



---

## Design Example Report

<b>Title</b>	<b><i>8 W Dimmable, Non-Isolated Buck-Boost LED Driver Using LYTSwitch™-4, LYT4322E</i></b>
<b>Specification</b>	195 VAC – 265 VAC Input; 72 V, 115 mA Output
<b>Application</b>	A19 LED Driver
<b>Author</b>	Applications Engineering Department
<b>Document Number</b>	DER-404
<b>Date</b>	December 5, 2013
<b>Revision</b>	1.0

### **Summary and Features**

- Single-stage power factor corrected (>0.9 at 230 V) and accurate constant current (CC) output
- Dimmable with high compatibility
- Low cost, low component count and small PCB footprint solution
- Highly energy efficient, >84 % at 240 VAC input
- High power factor; low THD
- Superior performance and end user experience
  - Fast start-up time (<150 ms) – no perceptible delay
- Integrated protection and reliability features
  - Single shot no-load protection, output short-circuit protected with auto-recovery
  - Auto-recovering thermal shutdown with large hysteresis protects both components and PCB
  - No damage during brown-out conditions
- Meets IEC ring wave, differential Line surge and EN55015 conducted EMI

### **PATENT INFORMATION**

The products and applications illustrated herein (including transformer construction and circuits external to the products) may be covered by one or more U.S. and foreign patents, or potentially by pending U.S. and foreign patent applications assigned to Power Integrations. A complete list of Power Integrations' patents may be found at [www.powerint.com](http://www.powerint.com). Power Integrations grants its customers a license under certain patent rights as set forth at <http://www.powerint.com/ip.htm>.

---

### **Power Integrations**

5245 Hellyer Avenue, San Jose, CA 95138 USA.

Tel: +1 408 414 9200 Fax: +1 408 414 9201

[www.powerint.com](http://www.powerint.com)

## Table of Contents

1	Introduction.....	4
2	Power Supply Specification .....	6
3	Schematic.....	7
4	Circuit Description .....	8
4.1	Input EMI Filtering .....	8
4.2	Dimming Compatibility - Active Bleeder, Passive RC Bleeder and Damper .....	8
4.3	LYTSwitch-4 .....	9
4.4	Output Rectification .....	9
4.5	Output Feedback.....	9
4.6	Shorted Load Protection.....	10
4.7	No-Load Protection .....	10
5	PCB Layout .....	11
6	Heat Sink Design.....	12
7	Bill of Materials .....	14
8	Inductor Design Spreadsheet.....	15
9	Inductor Design .....	18
9.1	Electrical Diagram .....	18
9.2	Electrical Specifications.....	18
9.3	Materials.....	18
9.4	Inductor Build Diagram .....	19
9.5	Inductor Construction .....	19
10	Performance Data.....	20
10.1	Mode Efficiency .....	21
10.2	Output Current Regulation.....	22
10.2.1	Input Line and Load Voltage to Output Current Regulation.....	22
10.3	Power Factor .....	23
10.4	Total Harmonic Distortion .....	24
10.5	Harmonic Content .....	25
11	Thermal Performance .....	27
11.1	Equipment Used.....	27
11.2	Thermal Result.....	28
11.3	Thermal Scan .....	30
12	Waveforms.....	32
12.1	Drain Voltage, Current Normal Operation.....	32
12.2	Drain Voltage and Current When Output Short .....	34
12.3	Drain Voltage and Current Start-up Profile .....	36
12.4	Output Current Start-up Profile.....	37
12.5	Input-Output Profile .....	38
12.6	Line Sag and Surge.....	40
12.7	No-Load Protection .....	41
12.8	Brown-out/ Brown-in .....	43
13	Dimming.....	44
13.1	Dimming compatibility .....	44



13.2 Dimming Waveforms .....45  
14 Line Surge .....87  
15 Conducted EMI .....90  
16 Revision History .....93

**Important Note:**

Although this board is designed to satisfy safety isolation requirements, the engineering prototype has not been agency approved. Therefore, all testing should be performed using an isolation transformer to provide the AC input to the prototype board.



## 1 Introduction

This document describes a cost effective LED Dimmable power supply driver utilizing the LYTSwitch-4 family (LYT4322E) in a highly compact buck-boost topology using a single-sided PCB.

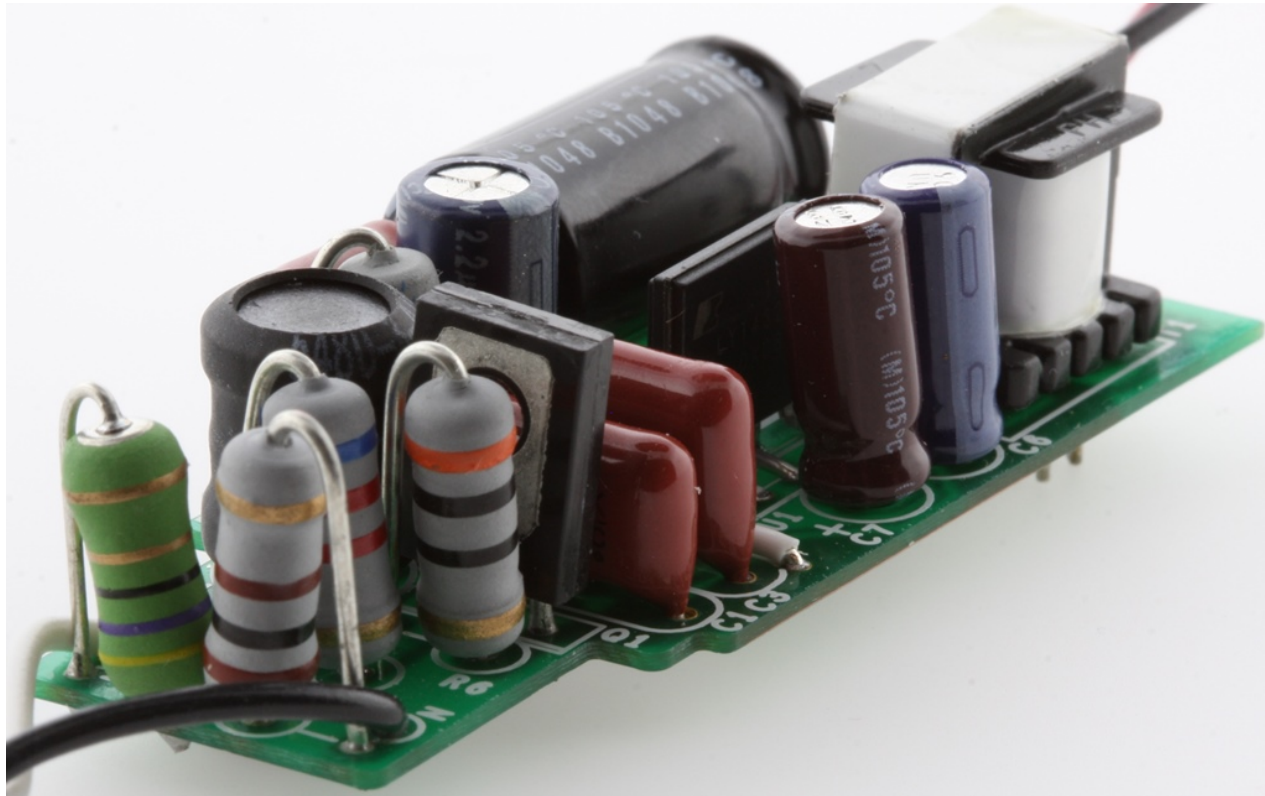


Figure 1 – Sample Unit.

This power supply operates over an input voltage range of 195 VAC to 265 VAC with a single stage active power factor correction with low harmonic distortion suitable for commercial and industrial application. The LED driver is dimmable for leading and trailing edge dimmers and compatible for majority of German, Italian, Australian and Chinese dimmers.

Other features such as auto-restart for open loop and output short-circuit conditions and line over-voltage protection that provides extended line fault and line surge withstand are incorporated in the device. Accurate hysteretic thermal shutdown that ensures safe average PCB temperatures under all conditions is also included. This integration minimizes the number of discrete components needed.

This document contains the LED driver specification, schematic, PCB information, bill of materials, transformer documentation and typical performance characteristics.





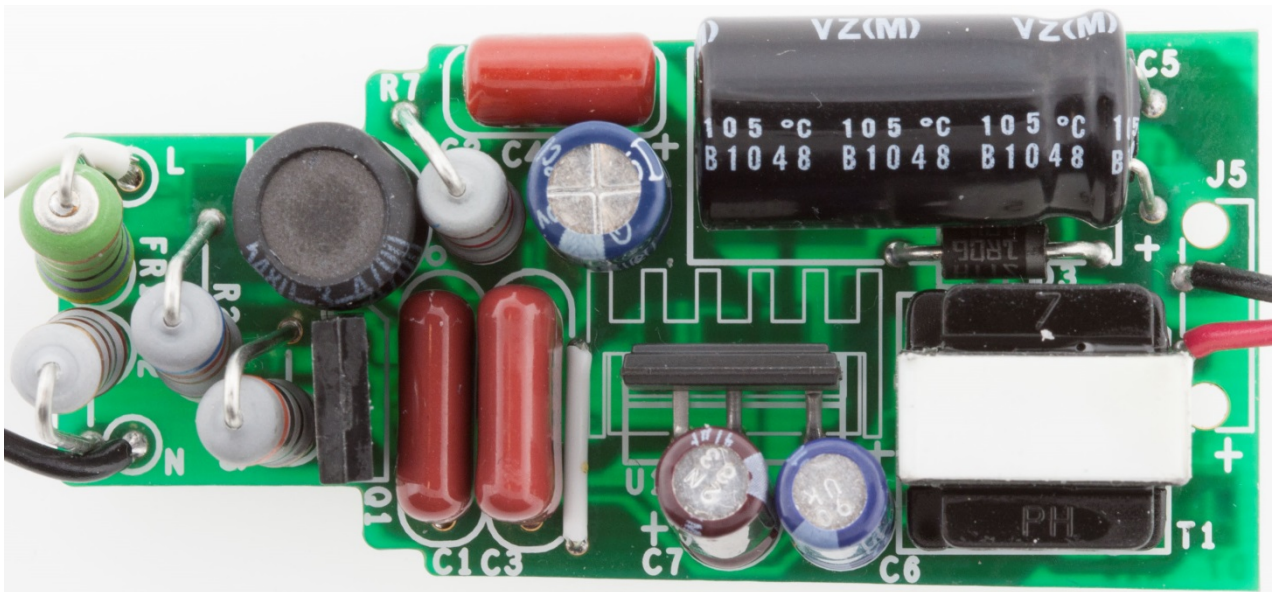


Figure 2 – Populated Circuit Board Photograph, Top.

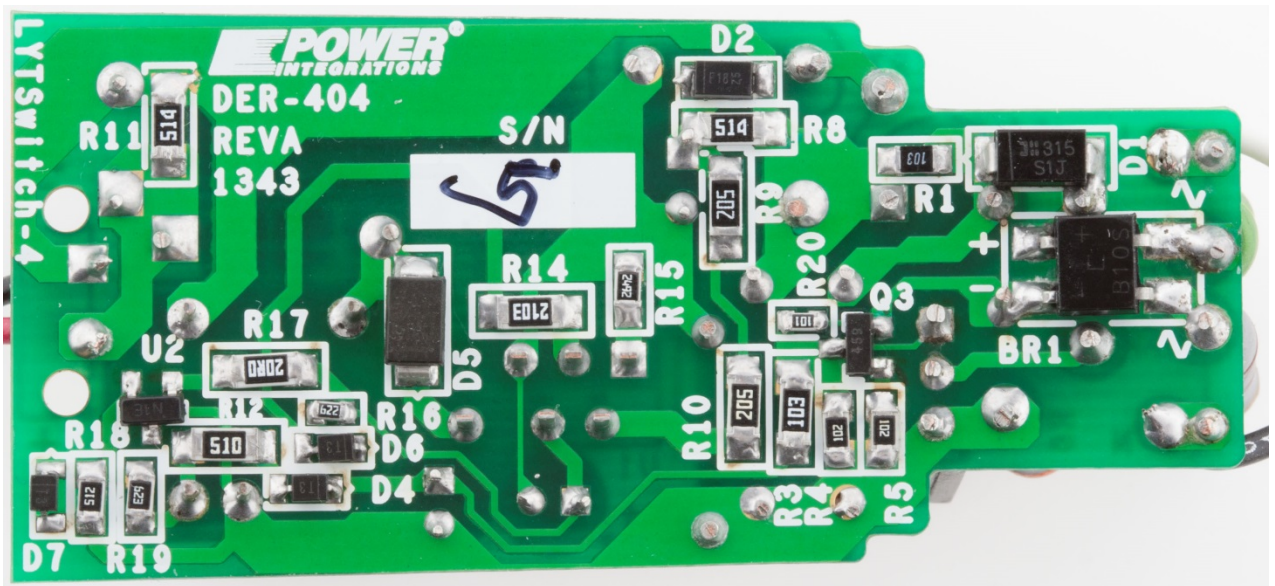


Figure 3 – Populated Circuit Board Photograph, Bottom.



## 2 Power Supply Specification

The table below represents the minimum acceptable performance for the design. Actual performance is listed in the results section.

Description	Symbol	Min	Typ	Max	Units	Comment
<b>Input</b>						
Voltage Operation	$V_{IN}$	195		265	VAC	2 Wire – no P.E. Operating frequency is not limited. Adjust sense resistor if application is for 400 Hz Line.
Frequency	$f_{LINE}$	47	50/60		Hz	
<b>Output</b>						
Output Voltage	$V_{OUT}$	68	72	76	V	±4% at 100 VAC - 240 VAC
Output Current	$I_{OUT}$		115		mA	
<b>Total Output Power</b>						
Continuous Output Power	$P_{OUT}$		8		W	
<b>Efficiency</b>						
240 VAC; 72 V LED	$\eta$	84			%	Measured at $P_{OUT}$ 25 °C
<b>Power Factor</b>						
240 VAC; 54 V LED	PF	0.9				Measured at $P_{OUT}$ 25 °C
<b>Environmental</b>						
Conducted EMI		Meets CISPR22B / EN55015B				
Line Surge Differential Mode (L1-L2)			0.5		kV	1.2/50 $\mu$ s surge, IEC 1000-4-5, Series Impedance: Differential Mode: 2 $\Omega$
Ring Wave (100 kHz) Differential Mode (L1-L2)			2.5		kV	500 A short circuit Series Impedance: Differential Mode: 12 $\Omega$
Ambient Temperature	$T_{AMB}$	-20	25		°C	Free convection, sea level



### 3 Schematic

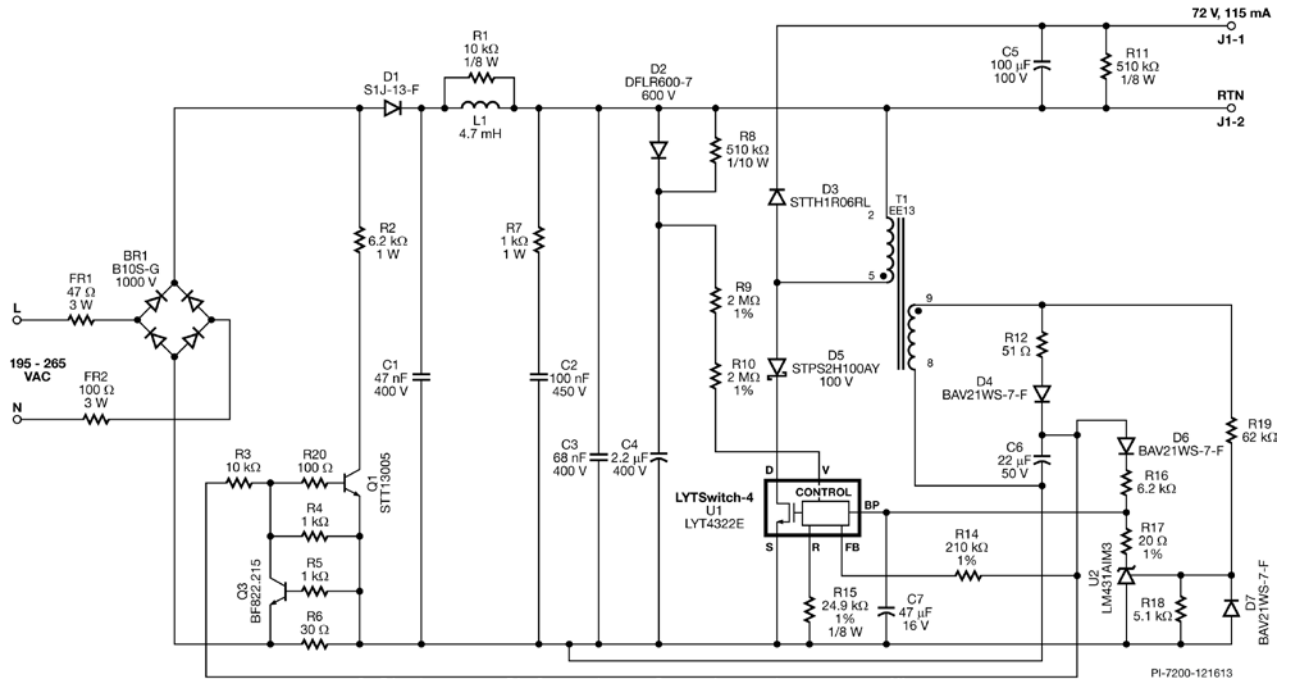


Figure 4 – Schematic.



## 4 Circuit Description

Low cost dimmable LED driver power supply uses LYT4322E (U1) in a buck-boost configuration to deliver a constant 115 mA current at a nominal output voltage of 72 VDC. The power supply is designed for non-isolated driving LEDs, which should always be driven with a constant current (CC). A non-isolated driver requires proper insulation for the driver and the metal housing of the retrofit lamp to meet safety.

### 4.1 Input EMI Filtering

Fuse RF1 provides short circuit protection. Bridge BR1 provides full wave rectification for good power factor and low harmonic content. Capacitor C1, C3 and common-mode choke L1 form a  $\pi$  filter in order meet conducted EMI standards. Capacitor C1 and C3 are also used for energy storage reducing line noise and protecting against line surge. Fusible resistor FR2 is a dampening resistor to reduce the ringing on the input current during dimming and this acts as a limiting impedance during line surges.

### 4.2 Dimming Compatibility - Active Bleeder, Passive RC Bleeder and Damper

The compatibility between the dimmable LED driver and the majority of high line dimmers in the market is achieved by adding an active bleeder to compensate for instantaneous currents below ~20 mA. This helps to maintain the holding current required by leading edge dimmers and to bias the supply of trailing edge dimmers during dimming. This is controlled by 9 components:

D1 – series blocking diode to avoid unwanted discharge of energy across the bulk capacitors (C1 and C2).

R2 – limiting bleeder resistor shares the power loss with Q1 when compensating for input current.

Q1 – biased linearly to compensate the current below the threshold as set by the sense-damper resistor R6 and Q3.

R20 – base current limiting resistor for Q1 to prevent avalanche during differential Line surge.

R3 – bias resistor from auxiliary of the LYTSwitch-4 converter.

R4 – base resistor to Q1 for faster response and stabilization.

Q3 – threshold transistor from the sense-damper resistor R6.

R5 – base current limiting resistor for Q3 to avoid avalanche during differential Line surge.

R6 – sense resistor and additional damper at the same time.

Unwanted ringing and input current oscillation occurs when operated with a leading edge dimmer. In order to damp this oscillation a passive RC bleeder (R7 and C2) was used. It is more effective to position these components after L1 to minimize the high frequency oscillations.



A total resistance of passive damper FR1, FR2 and R6 (177  $\Omega$ ) minimizes the peak current during the turn-on of leading edge dimmers. The passive damper can be replaced by an active damper for 2% efficiency improvement at minimal cost.

### **4.3 LYTSwitch-4**

LYTSwitch-4 is optimized to achieve a simple and cost effective Dimmable LED driver with good line regulation across temperature. The LYTSwitch-4 family has built-in thermal limit to protect the power supply in case the bulb is subjected to an excessive operating temperature.

The buck-boost converter stage consists of the integrated power MOSFET switch within LYTSwitch-4 (U1), a freewheeling diode D3; (a fast freewheeling diode was selected to minimize the switching losses), power inductor/transformer T1 and output capacitor (C5). The converter is operating mostly in continuous conduction mode (CCM) in order to minimize the rms loss during conduction time.

LYTSwitch-4 peak detector circuit C4, D2 and R8 provides the analogue information for the input voltage and it suppresses the line surge voltage during line disturbance to meet IEC 1000-4-5.

The line overvoltage shutdown function extends the rectified line voltage withstand (during surges and line swells) to the 725  $BV_{DSS}$  rating of the internal power MOSFET for high line family.

### **4.4 Output Rectification**

Fast output diode (D3) was used to achieve good efficiency and for thermal management, normally for LED applications, the ambient temperature is above 70  $^{\circ}C$ . A device with low  $t_{RR}$  (<35 nS) is recommended. The rectified energy by D3 is filtered by capacitor C5. For designs where higher ripple is acceptable and lower cost is required, the output capacitance value can be reduced.

### **4.5 Output Feedback**

Instead of regulating the output current via a sense resistor, LYTSwitch-4 has a proprietary approach in controlling the output current in order to achieve good efficiency. That is by measuring the equivalent output voltage through the bias winding of T1. The bias winding voltage is used to sense the output voltage indirectly, eliminating secondary side feedback components. The voltage on the bias winding is proportional to the output voltage (set by the turn ratio between the bias and secondary windings). Resistor R14 converts the bias voltage into a current which is fed into the FB pin of U1. The internal engine within U1 combines the FB pin current, the V pin current, and internal drain current information to provide a constant output current while maintaining high input power factor.



#### **4.6 Shorted Load Protection**

The part enters auto-restart whenever the FB current falls below the  $I_{FB(AR)}$  threshold for longer than the ~76 ms.

#### **4.7 No-Load Protection**

In the event of no-load operation, the output voltage is limited to 100 V. The output voltage is detected on the bias winding through the turns ratio of main and the bias winding. IC U2 will force the BP pin in auto-restart to regulate the output voltage. Divider R19 and R18 sets the overvoltage protection (OVP) threshold. Diode D7 is a reverse current protection for U2 and R17 is the bias resistor and limiting resistor for U2.



### 5 PCB Layout

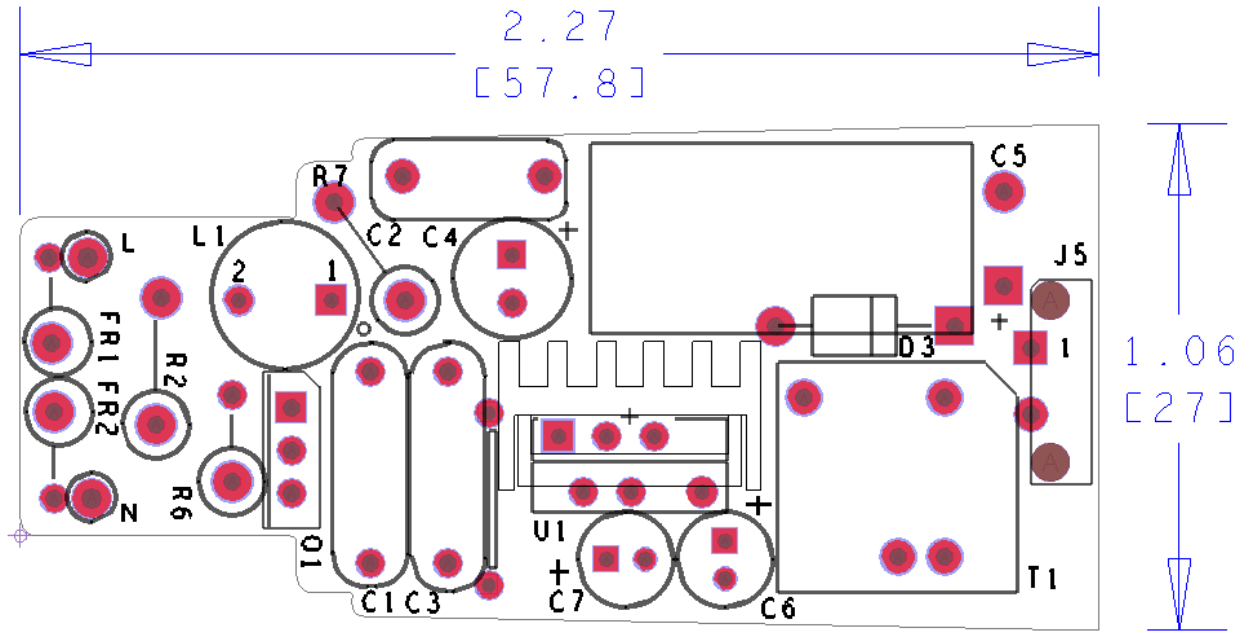


Figure 5 – Printed Circuit Layout. Top View.

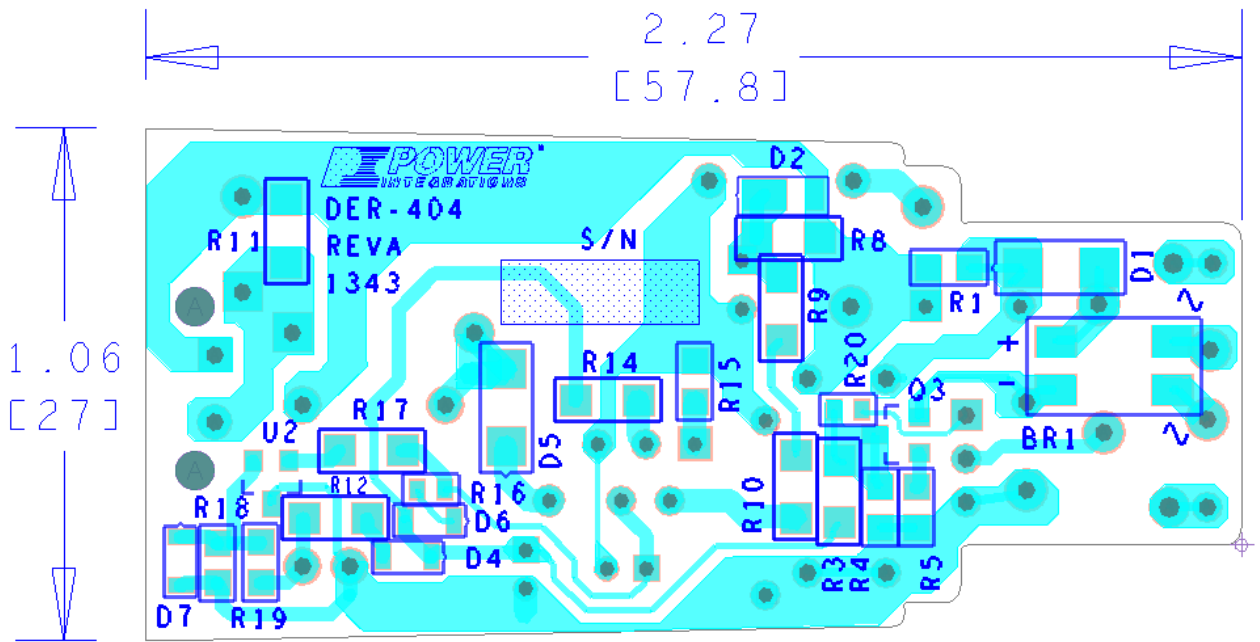
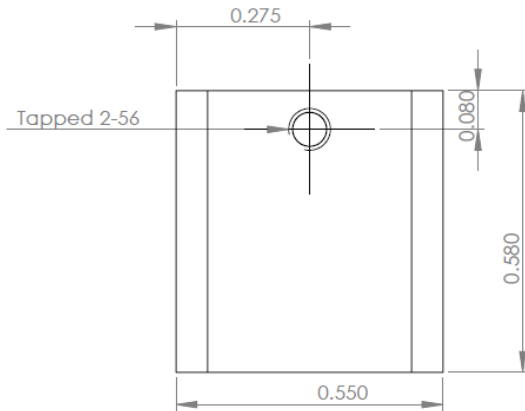


Figure 6 – Printed Circuit Layout. Bottom View.

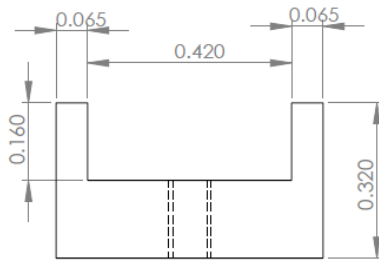


## 6 Heat Sink Design

Heat sink is not required if the system design is potted.



TOP VIEW



FRONT VIEW

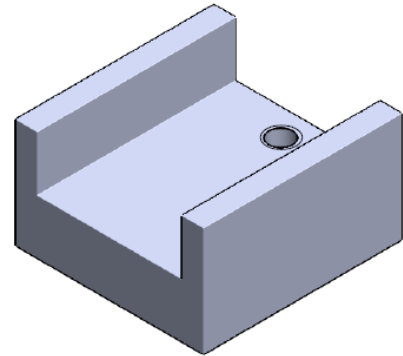


Figure 7 – U1 Heat Sink 1.





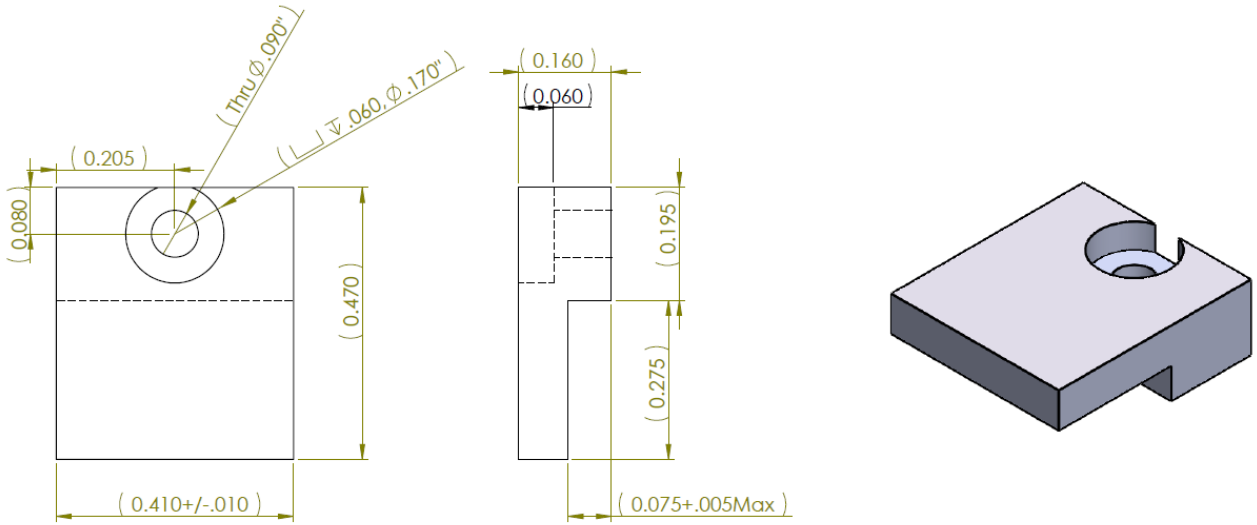


Figure 8 – U1 Heat Sink 2 for Clamping.

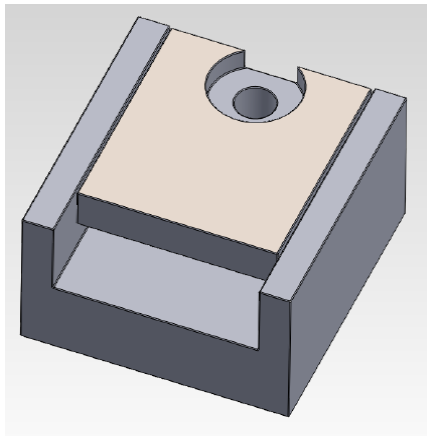


Figure 9 – U1 Heat Sink 2 Combination.



## 7 Bill of Materials

Below are the parts used in the build of the sample design. The design does not limit the selection of part, any alternative parts can be used for optimum cost in a given region.

Item	Qty	Ref Des	Description	Manufacturer P/N	Manufacturer
<b>Electrical</b>					
1	1	BR1	1000 V, 0.8 A, Bridge Rectifier, SMD, MBS-1, 4-SOIC	B10S-G	Comchip
2	1	C1	47 nF, 400 V, Film	ECQ-E4473KF	Panasonic
3	1	C2	100 nF, 450 V, Film	MEXXD31004JJ1	Duratech
4	1	C3	68 nF, 400 V, Film	ECQ-E4683KF	Panasonic
5	1	C4	2.2 $\mu$ F, 400 V, Electrolytic, (6.3 x 11)	TAB2GM2R2E110	Ltec
6	1	C5	100 $\mu$ F, 100 V, Electrolytic, Gen. Purpose, (10 x 20)	UVZ2A101MPD	Nichicon
7	1	C6	22 $\mu$ F, 50 V, Electrolytic, (5 x 11)	UPW1H220MDD	Nichicon
8	1	C7	47 $\mu$ F, 16 V, Electrolytic, Gen. Purpose, (5 x 11)	USV1C470MFD	Nichicon
9	1	D1	600 V, 1 A, Standard Recovery, SMA	S1J-13-F	Diodes, Inc.
10	1	D2	600 V, 1 A, Rectifier, Glass Passivated, POWERDI123	DFLR1600-7	Diodes, Inc.
11	1	D3	600 V, 1 A, Ultrafast Recovery, DO-41	STTH1R06RL	ST Micro
12	3	D4 D6 D7	250 V, 0.2 A, Fast Switching, 50 ns, SOD-323	BAV21WS-7-F	Diode, Inc.
13	1	D5	100 V, 2 A, Schottky, SMA	STPS2H100AY	ST Micro
14	2	FR1 FR2	75 R, 5%, 1 W, Metal Oxide	RSF100JB-75R	Yageo
15	1	L1	4.7 mH, 0.150 A, 20%	RL-5480-3-4700	Renco Elect, Inc
16	1	Q1	NPN, NPN FAST SW BIPO SOT-32, TO-126-3	STT13005	ST Micro
17	1	Q3	TRANS NPN 250V 50MA SOT23	BF822.215	NXP
18	1	R1	10 k $\Omega$ , 5%, 1/8 W, Thick Film, 0805	ERJ-6GEYJ103V	Panasonic
19	1	R2	6.2 k $\Omega$ , 5%, 1 W, Metal Oxide	RSF100JB-6K2	Yageo
20	1	R3	10 k $\Omega$ , 5%, 1/4 W, Thick Film, 1206	ERJ-8GEYJ103V	Panasonic
21	2	R4 R5	1 k $\Omega$ , 5%, 1/8 W, Thick Film, 0805	ERJ-6GEYJ102V	Panasonic
22	1	R6	30 $\Omega$ , 5%, 1 W, Metal Oxide	RSF100JB-30R	Yageo
23	1	R7	1 k $\Omega$ , 5%, 1 W, Metal Oxide	RSF100JB-1K0	Yageo
24	2	R8 R11	510 k $\Omega$ , 5%, 1/4 W, Thick Film, 1206	ERJ-8GEYJ514V	Panasonic
25	2	R9 R10	2 M $\Omega$ , 5%, 1/4 W, Thick Film, 1206	ERJ-8GEYJ205V	Panasonic
26	1	R12	51 $\Omega$ , 5%, 1/4 W, Thick Film, 1206	ERJ-8GEYJ510V	Panasonic
27	1	R14	221 k $\Omega$ , 1%, 1/4 W, Thick Film, 1206	ERJ-8ENF2213V	Panasonic
28	1	R15	24.9 k $\Omega$ , 1%, 1/8 W, Thick Film, 0805	ERJ-6ENF2492V	Panasonic
29	1	R16	6.2 k $\Omega$ , 5%, 1/10 W, Thick Film, 0603	ERJ-3GEYJ622V	Panasonic
30	1	R17	20 $\Omega$ , 1%, 1/4 W, Thick Film, 1206	ERJ-8ENF20R0V	Panasonic
31	1	R18	5.1 k $\Omega$ , 5%, 1/8 W, Thick Film, 0805	ERJ-6GEYJ512V	Panasonic
32	1	R19	62 k $\Omega$ , 5%, 1/8 W, Thick Film, 0805	ERJ-6GEYJ623V	Panasonic
33	1	R20	100 $\Omega$ , 5%, 1/10 W, Thick Film, 0603	ERJ-3GEYJ101V	Panasonic
34	1	T1	Custom, EE13, Vertical, 10 pins	Custom	Custom
35	1	U1	LYTSwitch, eSIP-7C	LYT4322E	Power Integrations
36	1	U2	IC, REG ZENER SHUNT ADJ SOT-23	LM431AIM3/NOPB	National Semi
<b>Mechanical</b>					
16	1	WIRE(V-)	Wire, UL1007, #24 AWG, Blk, PVC, 4"	1007-24/7-0	Anixter
17	1	WIRE (L)	Wire, UL1007, #24 AWG, Blu, PVC, 4"	1007-24/7-6	Anixter
18	1	WIRE(V+)	Wire, UL1007, #24 AWG, Red, PVC, 4"	1007-24/7-2	Anixter
19	1	WIRE(N)	Wire, UL1007, #24 AWG, Wht, PVC, 4"	1007-24/7-9	Anixter
20	1	PCB	FR4, 0.31, 1Oz Cu (0.51" X 2.1")		

Note: Reverse voltage <100 on the DRAIN pin. Diode D5 voltage rating is 100 V minimum.



## 8 Inductor Design Spreadsheet

ACDC_LYTSwitch-4_HL_062013; Rev.1.0; Copyright Power Integrations 2013	INPUT	INFO	OUTPUT	UNIT	LYTSwitch-4_HL_062013: Flyback Transformer Design Spreadsheet
<b>ENTER APPLICATION VARIABLES</b>					
Dimming required	YES		YES		Select 'YES' option if dimming is required. Otherwise select 'NO'.
VACMIN			195	V	Minimum AC Input Voltage
VACMAX			265	V	Maximum AC input voltage
fL			50	Hz	AC Mains Frequency
VO	72.00		72	V	Typical output voltage of LED string at full load
VO_MAX			79.20	V	Maximum expected LED string Voltage.
VO_MIN			64.80	V	Minimum expected LED string Voltage.
V_OVP			87.12	V	Over-voltage protection setpoint
IO	0.12		0.12	A	Typical full load LED current
PO			8.6	W	Output Power
n			0.8		Estimated efficiency of operation
VB			25	V	Bias Voltage
<b>ENTER LYTSwitch VARIABLES</b>					
LYTSwitch	LYT4322		LYT4322		Selected LYTSwitch
Current Limit Mode	RED		RED		Select "RED" for reduced Current Limit mode or "FULL" for Full current limit mode
ILIMITMIN			0.65	A	Minimum current limit
ILIMITMAX			0.76	A	Maximum current limit
fS			132000	Hz	Switching Frequency
fSmin			124000	Hz	Minimum Switching Frequency
fSmax			140000	Hz	Maximum Switching Frequency
IV			80.6	uA	V pin current
RV			4	M-ohms	Upper V pin resistor
RV2			100000000000	M-ohms	Lower V pin resistor
IFB			114.7	uA	FB pin current (85 uA < IFB < 210 uA)
RFB1			191.9	k-ohms	FB pin resistor
VDS			10	V	LYTSwitch on-state Drain to Source Voltage
VD			0.50	V	Output Winding Diode Forward Voltage Drop (0.5 V for Schottky and 0.8 V for PN diode)
VDB			0.70	V	Bias Winding Diode Forward Voltage Drop
<b>Key Design Parameters</b>					
KP	1.00		1.00		Ripple to Peak Current Ratio (For PF > 0.9, 0.4 < KP < 0.9)
LP			815	uH	Primary Inductance
VOR	72.00		72	V	Reflected Output Voltage.
Expected IO (average)			0.12	A	Expected Average Output Current
KP_VNOM			0.96		Expected ripple current ratio at VACNOM
TON_MIN			1.22	us	Minimum on time at maximum AC input voltage
PCLAMP			0.07	W	Estimated dissipation in primary clamp
<b>ENTER TRANSFORMER CORE/CONSTRUCTION VARIABLES</b>					
Core Type	EF20		EF20		Select Core Size
Custom Core					Enter Custom core part number (if applicable)
AE	0.17		0.17	cm^2	Core Effective Cross Sectional Area
LE	3.02		3.02	cm	Core Effective Path Length



AL	1130.00		1130	nH/T <sup>2</sup>	Ungapped Core Effective Inductance
BW	7.40		7.4	mm	Bobbin Physical Winding Width
M	0.00		0	mm	Safety Margin Width (Half the Primary to Secondary Creepage Distance)
L	4.00		4		Number of Primary Layers
NS			106		Number of Secondary Turns
<b>DC INPUT VOLTAGE PARAMETERS</b>					
VMIN			276	V	Peak input voltage at VACMIN
VMAX			375	V	Peak input voltage at VACMAX
<b>CURRENT WAVEFORM SHAPE PARAMETERS</b>					
DMAX			0.21		Minimum duty cycle at peak of VACMIN
IAVG			0.05	A	Average Primary Current
IP			0.57	A	Peak Primary Current (calculated at minimum input voltage VACMIN)
IRMS			0.13	A	Primary RMS Current (calculated at minimum input voltage VACMIN)
<b>TRANSFORMER PRIMARY DESIGN PARAMETERS</b>					
LP			815	uH	Primary Inductance
LP_TOL			10		Tolerance of primary inductance
NP			105		Primary Winding Number of Turns
NB			38		Bias Winding Number of Turns
ALG			74	nH/T <sup>2</sup>	Gapped Core Effective Inductance
BM			2582	Gaus s	Maximum Flux Density at PO, VMIN (BM<3100)
BP			3459	Gaus s	Peak Flux Density (BP<3700)
BAC			1291	Gaus s	AC Flux Density for Core Loss Curves (0.5 X Peak to Peak)
ur			1597		Relative Permeability of Ungapped Core
LG			0.27	mm	Gap Length (Lg > 0.1 mm)
BWE			29.6	mm	Effective Bobbin Width
OD			0.28	mm	Maximum Primary Wire Diameter including insulation
INS			0.05	mm	Estimated Total Insulation Thickness (= 2 * film thickness)
DIA			0.23	mm	Bare conductor diameter
AWG			31	AWG	Primary Wire Gauge (Rounded to next smaller standard AWG value)
CM			81	Cmils	Bare conductor effective area in circular mils
CMA		Info	635	Cmils /Amp	!!! Info. Decrease CMA (200 < CMA < 600) Decrease L(primary layers),increase NS,smaller Core
<b>TRANSFORMER SECONDARY DESIGN PARAMETERS (SINGLE OUTPUT EQUIVALENT)</b>					
<b>Lumped parameters</b>					
ISP			0.56	A	Peak Secondary Current
ISRMS			0.22	A	Secondary RMS Current
IRIPPLE			0.19	A	Output Capacitor RMS Ripple Current
CMS			44	Cmils	Secondary Bare Conductor minimum circular mils
AWGS			33	AWG	Secondary Wire Gauge (Rounded up to next larger standard AWG value)
DIAS			0.18	mm	Secondary Minimum Bare Conductor Diameter
ODS			0.07	mm	Secondary Maximum Outside Diameter for Triple Insulated Wire
<b>VOLTAGE STRESS PARAMETERS</b>					
VDRAIN			529	V	Estimated Maximum Drain Voltage assuming maximum LED string voltage (Includes Effect of Leakage Inductance)
PIVS			464	V	Output Rectifier Maximum Peak Inverse Voltage (calculated at VOVP, excludes leakage inductance spike)
PIVB			164	V	Bias Rectifier Maximum Peak Inverse Voltage (calculated at VOVP, excludes leakage inductance spike)



FINE TUNING (Enter measured values from prototype)					
V pin Resistor Fine Tuning					
RV1	4.00		4.00	M-ohms	Upper V Pin Resistor Value
RV2			100000000 0000	M-ohms	Lower V Pin Resistor Value
VAC1	195.00		195.0	V	Test Input Voltage Condition1
VAC2	265.00		265.0	V	Test Input Voltage Condition2
IO_VAC1	0.11		0.11	A	Measured Output Current at VAC1
IO_VAC2	0.12		0.12	A	Measured Output Current at VAC2
RV1 (new)			3.32	M-ohms	New RV1
RV2 (new)			0.16	M-ohms	New RV2
V_OV			310.3	V	Typical AC input voltage at which OV shutdown will be triggered
V_UV			100.3	V	Typical AC input voltage beyond which power supply can startup
FB pin resistor Fine Tuning					
RFB1	210.00		210	k-ohms	Upper FB Pin Resistor Value
RFB2			100000000 0000	k-ohms	Lower FB Pin Resistor Value
VB1			22.4	V	Test Bias Voltage Condition1
VB2			27.6	V	Test Bias Voltage Condition2
IO1			0.12	A	Measured Output Current at Vb1
IO2			0.12	A	Measured Output Current at Vb2
RFB1 (new)			210.0	k-ohms	New RFB1
RFB2(new)			100000000 0000.0000	k-ohms	New RFB2
Input Current Harmonic Analysis					
Harmonic			Max Current (mA)	Limit (mA)	
1st Harmonic					
3rd Harmonic			12.43	317.26	PASS. 3rd Harmonic current content is lower than the limit
5th Harmonic			6.6	177.29	PASS. 5th Harmonic current content is lower than the limit
7th Harmonic			4.1	93.31	PASS. 7th Harmonic current content is lower than the limit
9th Harmonic			2.95	46.66	PASS. 9th Harmonic current content is lower than the limit
11th Harmonic			2.20	32.66	PASS. 11th Harmonic current content is lower than the limit
13th Harmonic			1.70	27.63	PASS. 13th Harmonic current content is lower than the limit
15th Harmonic			1.38	23.94	PASS. 15th Harmonic current content is lower than the limit
THD			31.7	%	Estimated total Harmonic Distortion (THD)



## 9 Inductor Design

### 9.1 Electrical Diagram

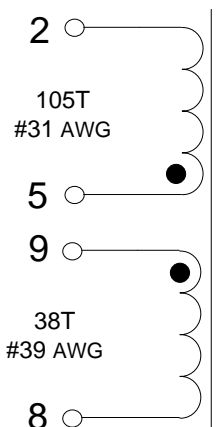


Figure 10 – Transformer Electrical Diagram.

### 9.2 Electrical Specifications

<b>Primary Inductance</b>	Pins 2-5, all other windings open, measured at 100 kHz, 0.4 V <sub>RMS</sub>	815 μH ±7%
---------------------------	--	------------

### 9.3 Materials

Item	Description
[1]	Core: EE13; NC2H or equivalent.
[2]	Bobbin: EE13;5/5 pin Vertical;Pin Shine, P-1302-2 or equivalent.
[3]	Magnet Wire: #31 AWG.
[4]	Magnet Wire: #39 AWG.
[5]	Transformer tape: 6.5 mm.



### 9.4 Inductor Build Diagram

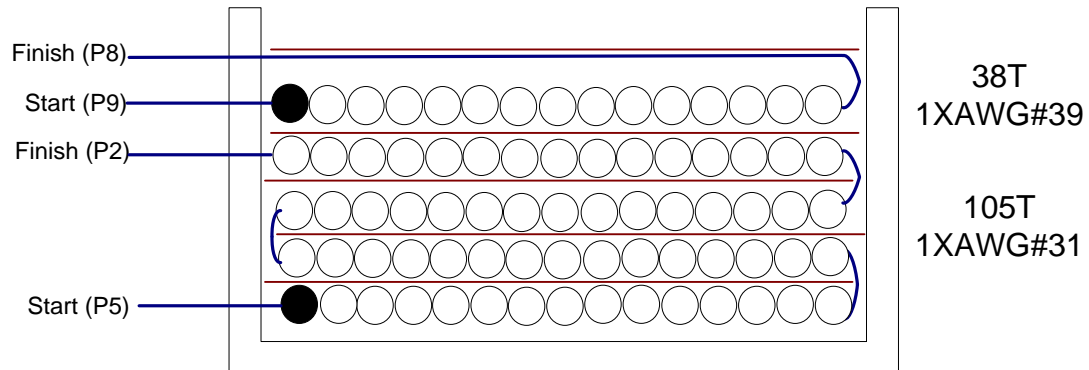


Figure 11 – Transformer Build Diagram.

### 9.5 Inductor Construction

<b>Bobbin Preparation</b>	For the purpose of these instructions, bobbin is oriented on winder such that pin 1 side is on the left. Winding direction is counter-clockwise. Follow the pin number assignment in the specification.
<b>WDG 1</b>	Start at pin 5. Wind 105 turns of item [3] and terminate at pin 1. Note that there is one turn of transformer tape item[5] per layer
<b>Insulation</b>	Add 1 layer of tape of item [5].
<b>WDG 2</b>	Start at pin 9. Wind 38 turns of item [4] and terminate at pin 8.
<b>Taping</b>	Add 1 layer of tape to secure the winding.
<b>Final Assembly</b>	Grind the core to get the specified inductance. Secure the core with tape.



### 10 Performance Data

All measurements performed at room temperature (~25 °C) otherwise specified.

Input		Input Measurement					LED Load Measurement			Efficiency (%)	Reg (%)
VAC (V <sub>RMS</sub> )	Freq (Hz)	V <sub>IN</sub> (V <sub>RMS</sub> )	I <sub>IN</sub> (mA <sub>RMS</sub> )	P <sub>IN</sub> (W)	PF	% THD	V <sub>OUT</sub> (V <sub>DC</sub> )	I <sub>OUT</sub> (mA <sub>DC</sub> )	P <sub>OUT</sub> (W)		
Vo min											
195	50	194.96	48.57	8.913	0.941	25.94	68.0	110.6	7.53	84.48	84.48
200	50	199.93	47.73	8.951	0.938	26.33	68.0	111.2	7.57	84.57	84.57
230	50	229.94	43.94	9.275	0.918	28.48	68.2	115.0	7.85	84.64	84.64
240	50	239.97	42.87	9.374	0.911	29.3	68.2	115.8	7.91	84.38	84.38
265	50	265.02	40.77	9.672	0.895	31.52	68.3	117.6	8.05	83.23	83.23
Vo nom											
195	50	194.96	51.78	9.548	0.946	25.35	72.0	111.8	8.06	84.42	84.42
200	50	199.94	50.69	9.549	0.942	25.81	72.0	112.0	8.08	84.62	84.62
230	50	229.94	46.28	9.819	0.923	27.85	72.2	115.3	8.34	84.94	84.94
240	50	239.97	45.03	9.893	0.916	28.6	72.2	116.0	8.40	84.91	84.91
265	50	265.03	42.59	10.148	0.899	30.66	72.3	117.7	8.52	83.96	83.96
Vo max											
195	50	194.96	54.91	10.162	0.949	24.97	76.0	112.6	8.57	84.33	84.33
200	50	199.93	53.79	10.177	0.946	25.33	75.9	113.0	8.60	84.50	84.50
230	50	229.94	48.72	10.385	0.927	27.33	76.1	115.9	8.84	85.12	85.12
240	50	239.97	47.30	10.446	0.920	27.97	76.1	116.5	8.88	85.01	85.01
265	50	265.02	44.55	10.669	0.904	29.77	76.2	118.0	9.01	84.45	84.45

Table 1 – Raw Data.





### 10.1 Mode Efficiency

Measured at 25 °C ambient, open frame.

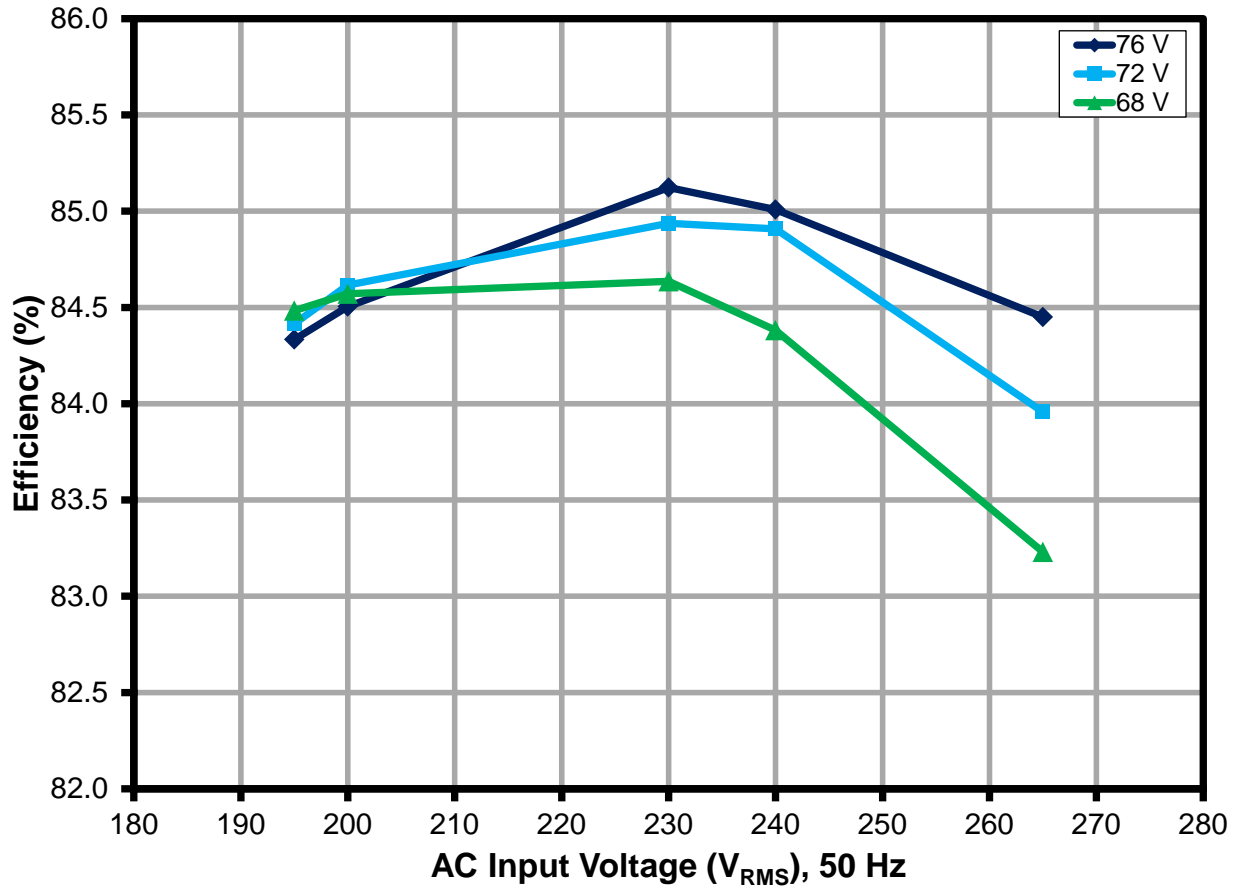


Figure 12 – Efficiency with Respect to AC Input Voltage. 195-265 VAC (60 Hz) Input.



### 10.2 Output Current Regulation

#### 10.2.1 Input Line and Load Voltage to Output Current Regulation

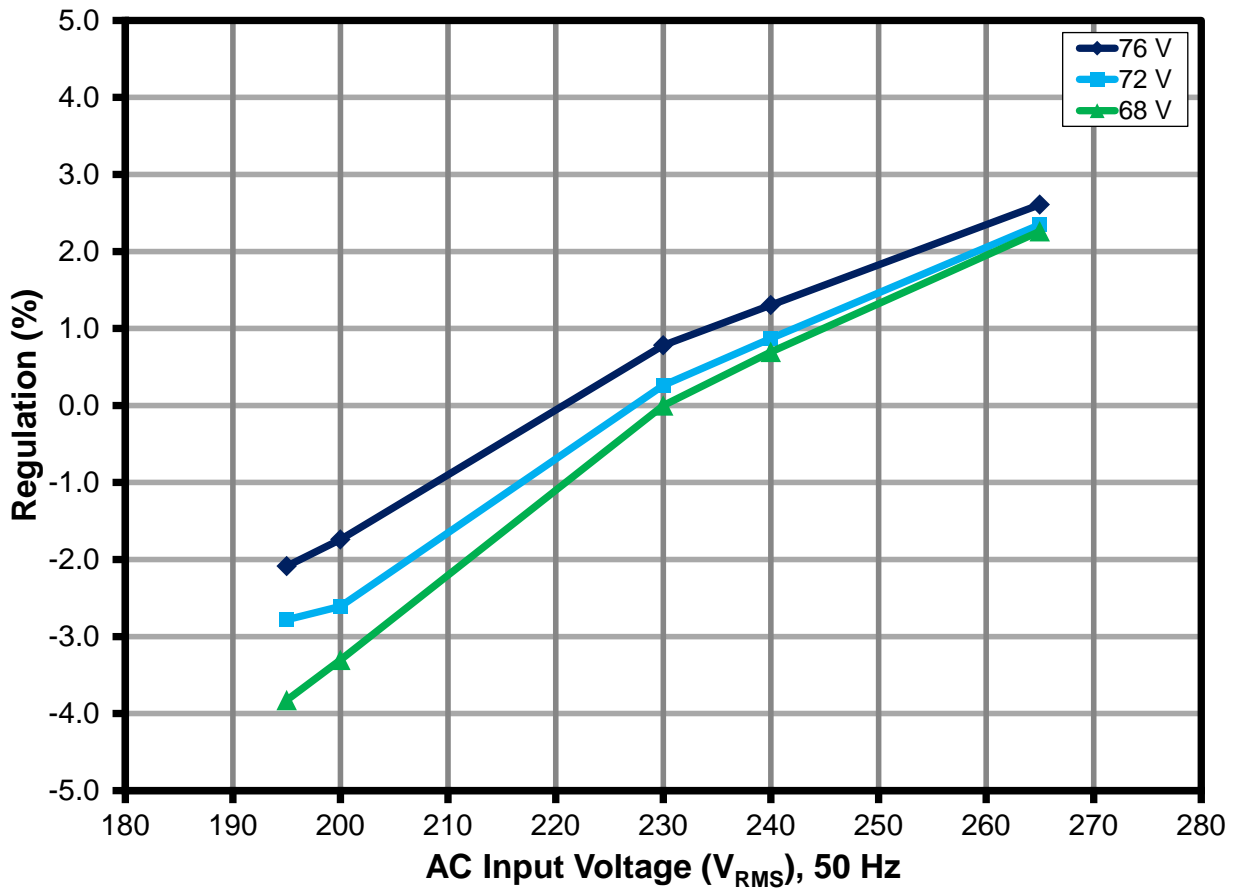


Figure 13 – Load Regulation, Room Temperature.



### 10.3 Power Factor

Measured at 25 °C ambient, open frame.

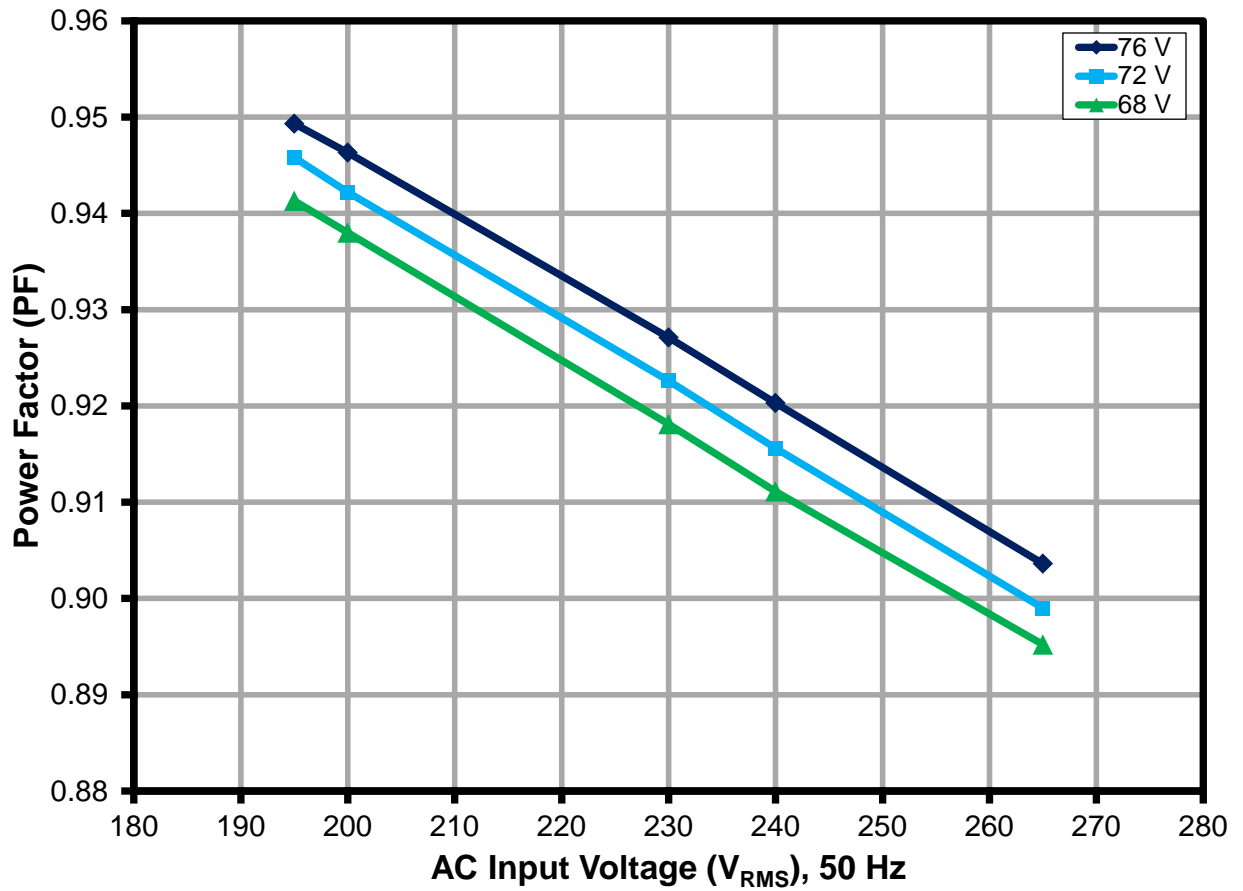


Figure 14 – Power Factor, Room Temperature.



### 10.4 Total Harmonic Distortion

Measured at 25 °C ambient, open frame.

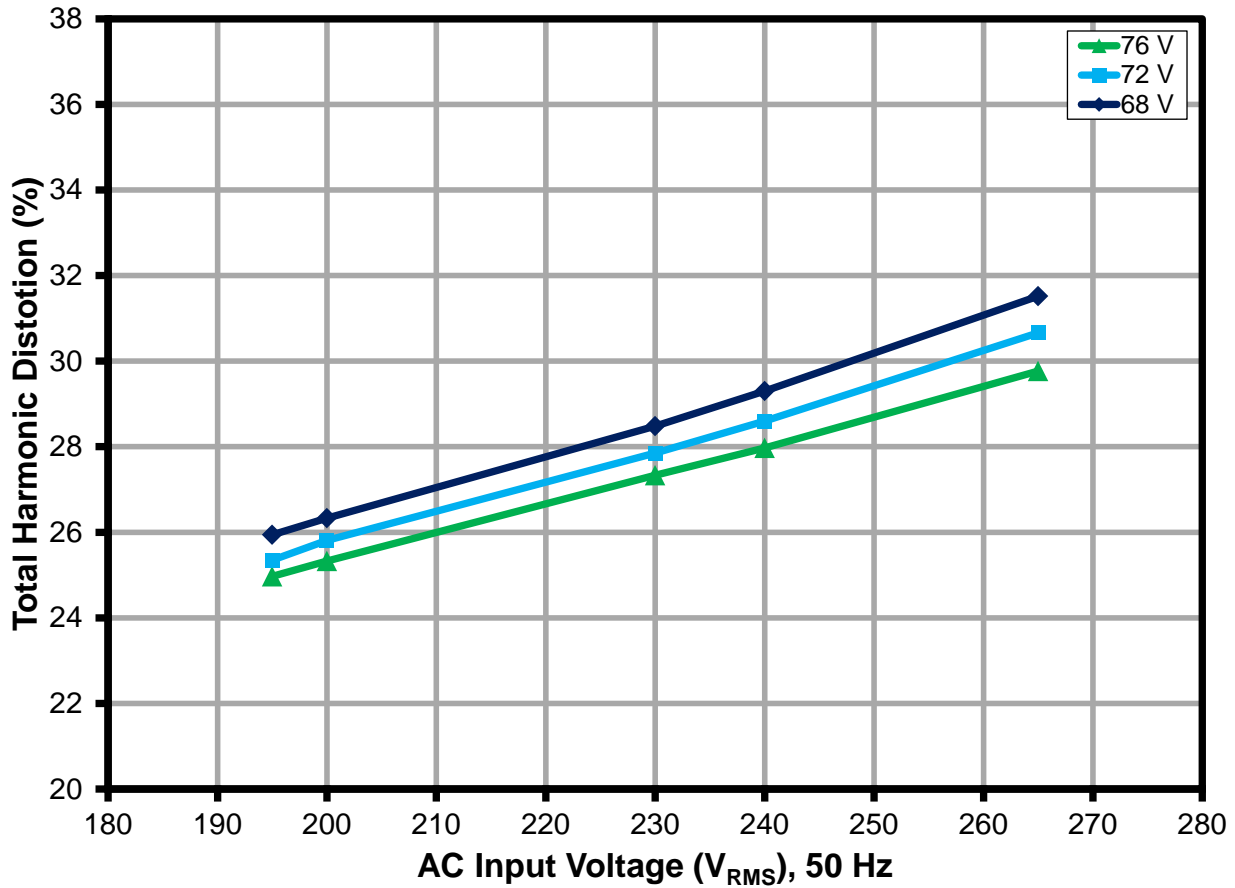


Figure 15 – %THD, Room Temperature.



### 10.5 Harmonic Content

Measured at 25 °C ambient, open frame. Load: 72 V LED

V	Freq	I (mA)	P	PF	%THD
240	50.00	45.03	9.8930	0.9156	28.6
nth Order	mA Content	% Content	Limit <25 W	Remarks	
1	43.29				
2	0.02	0.04			
3	9.45	21.84	33.64	Pass	
5	6.09	14.07	18.80	Pass	
7	3.27	7.55	9.89	Pass	
9	2.96	6.84	4.95	Pass	
11	1.28	2.95	3.46	Pass	
13	1.46	3.38	2.93	Pass	
15	0.62	1.43	2.54	Pass	
17	0.93	2.14	2.24	Pass	
19	0.48	1.10	2.00	Pass	
21	0.64	1.47	1.81	Pass	
23	0.46	1.05	1.66	Pass	
25	0.51	1.18	1.52	Pass	
27	0.48	1.10	1.41	Pass	
29	0.45	1.03	1.31	Pass	
31	0.42	0.97	1.23	Pass	
33	0.35	0.81	1.15	Pass	
35	0.33	0.75	1.09	Pass	
37	0.27	0.62	1.03	Pass	
39	0.28	0.64	0.98	Pass	
41	0.23	0.54			
43	0.23	0.53			
45	0.19	0.45			
47	0.18	0.42			
49	0.20	0.46			

Table 2 – Harmonic Content at 240 V, 72 V LED Load.



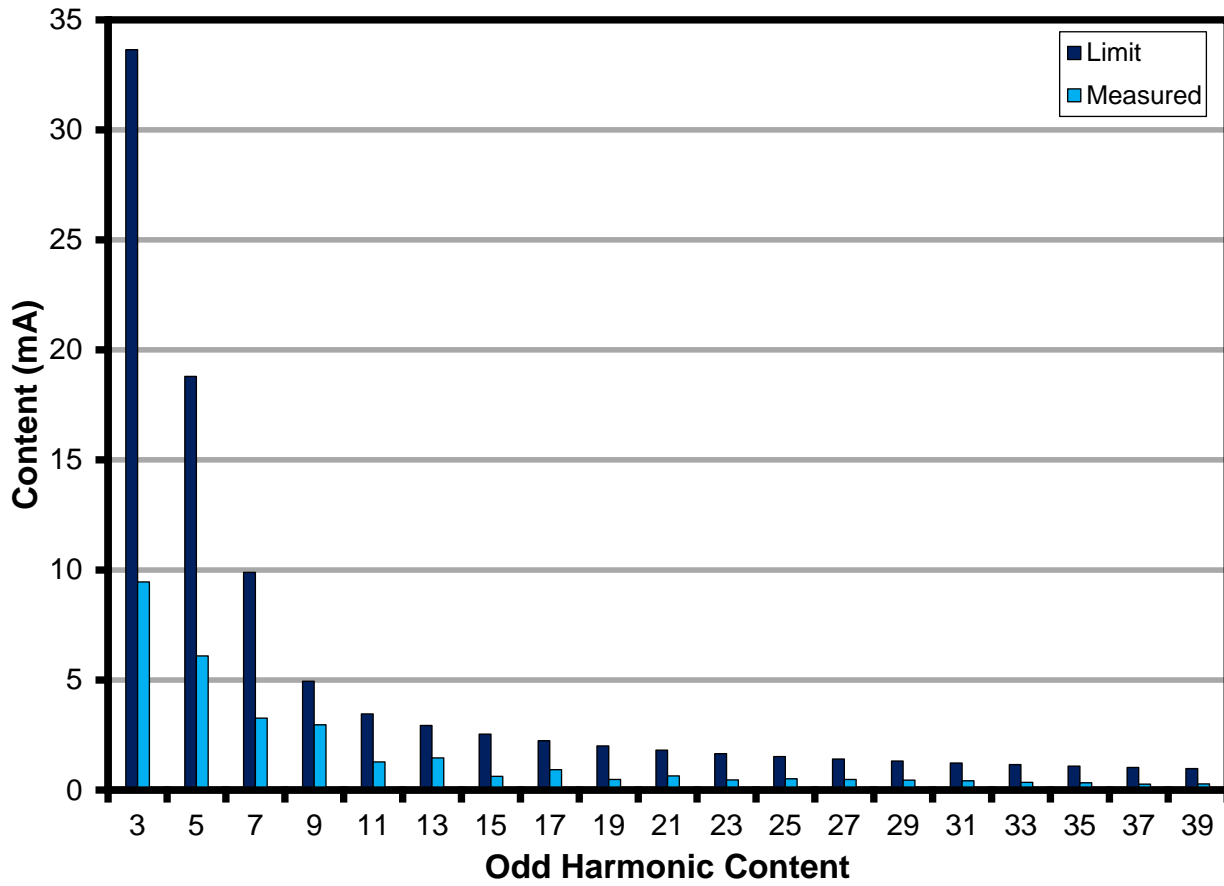


Figure 16 – Harmonic Content, Room Temperature.



## 11 Thermal Performance

### 11.1 Equipment Used

Chamber:	Tenney Environmental Chamber Model No: TJR-17 942	Wattmeter:	Yokogawa Power Meter Model No: WT2000
AC Source:	Chroma Programmable AC Source Model No: 6415	Data Logger:	Agilent



**Figure 17** – Thermal Chamber Set-up Showing Box Used to Prevent Airflow Over UUT. Open Frame Set-up Measurement.



**Figure 18** – Thermal Unit Thermocouple Measurement Set-up.

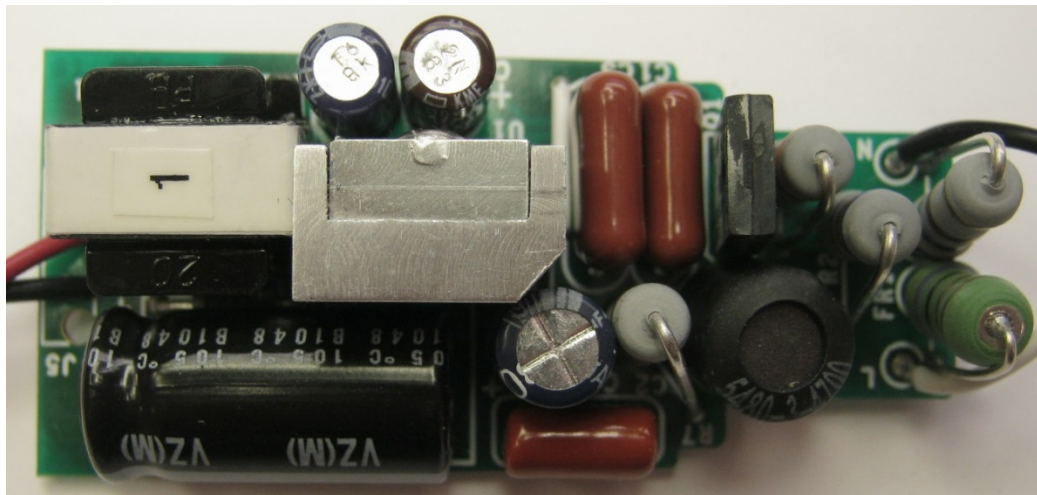
**Note:** Typical A19 enclosure is used in the verification.

**11.2 Thermal Result**

Load: 72 V / 115 m A LED load in a standard A19.

Remarks	External Ambient °C	Internal Ambient °C	LYT4322E °C	L1;EMI Inductor °C	TRF °C	BR °C	Output Diode °C
Normal Operation Open Frame in the Thermal Chamber 195 V / 50 Hz	20	77.201	89.775	74.156	87.107	80.621	83.485
	30	85.214	98.664	81.992	95.039	88.324	91.526
	40	93.288	107.379	89.969	103.12	96.217	99.751
	50	101.436	115.298	98.268	111.483	104.187	108.028
	60	109.391	122.862	106.171	119.597	111.99	116.073
	70	117.048	132.062	113.899	127.464	119.386	124.062
Normal Operation Open Frame in the Thermal Chamber 195 V / 50 Hz	20	82.468	97.413	78.321	94.615	81.872	89.841
	30	90.235	105.86	86.31	102.329	89.556	97.674
	40	98.159	113.916	94.325	110.368	97.492	105.659
	50	106.465	121.373	102.681	118.875	105.811	113.94
	60	114.527	130.029	110.884	127.147	113.944	122.109
	65	118.451	133.979	114.843	131.103	118.042	126.044
OTP; 195 V / 50 Hz	76	122	137	118	132	124	129
OTP; 265 V / 50 Hz	66	120	137	116	133	119	127

**Table 3** – Thermal Measurement, U1 with Heat Sink.



**Figure 19** – Sample Design with Heat Sink.

**Note:** The heat sink is optional and depends on the end system design. In some applications the heat sink is not required or potting may be used.





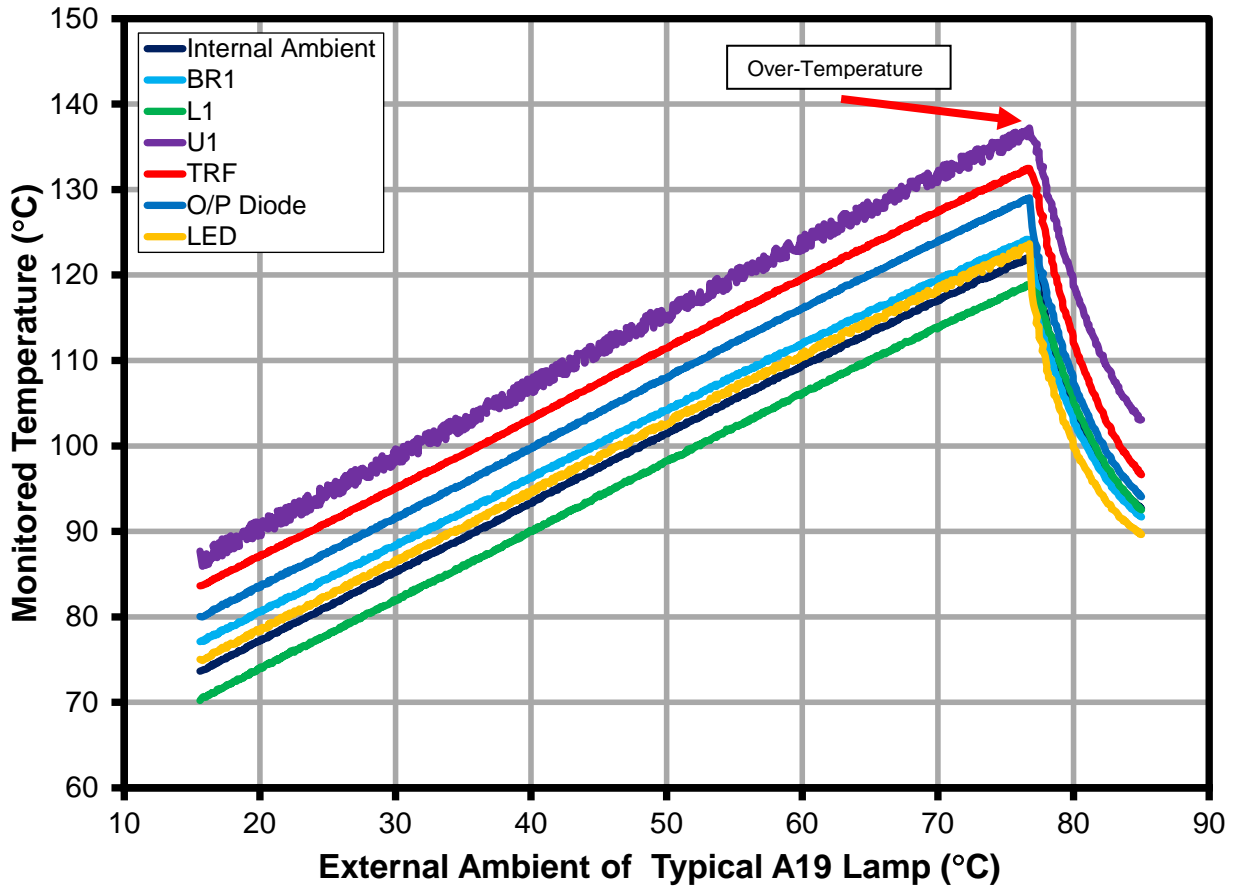
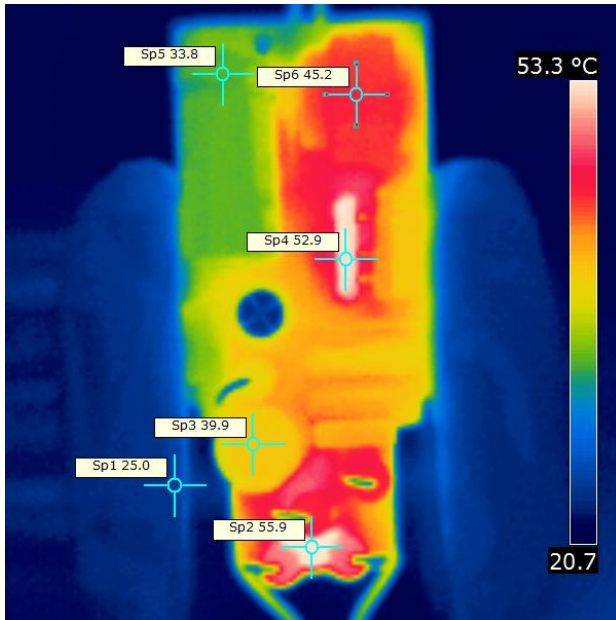


Figure 20 – Thermal Curve at 195 VAC / 50 Hz Input in Typical A19 Housing. LYT4322EG with heatsink.

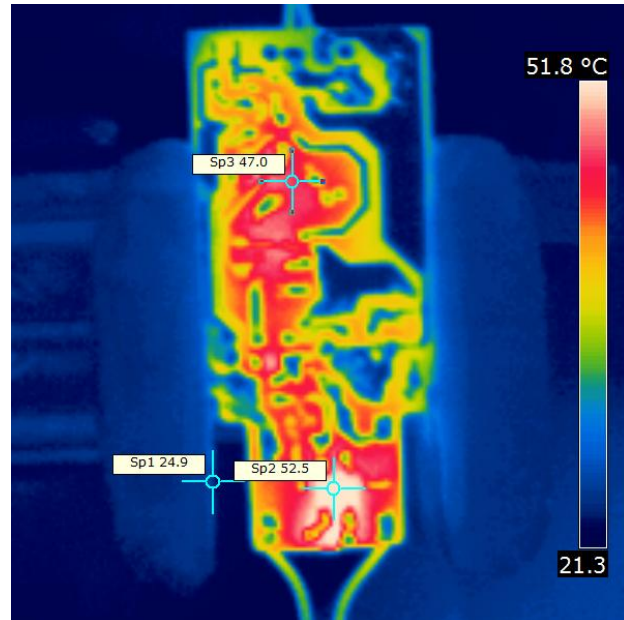


### 11.3 Thermal Scan

Open-frame thermal measurement at 25 °C ambient. UUT was soaked for 1 hour to achieve steady-state before the measurement.

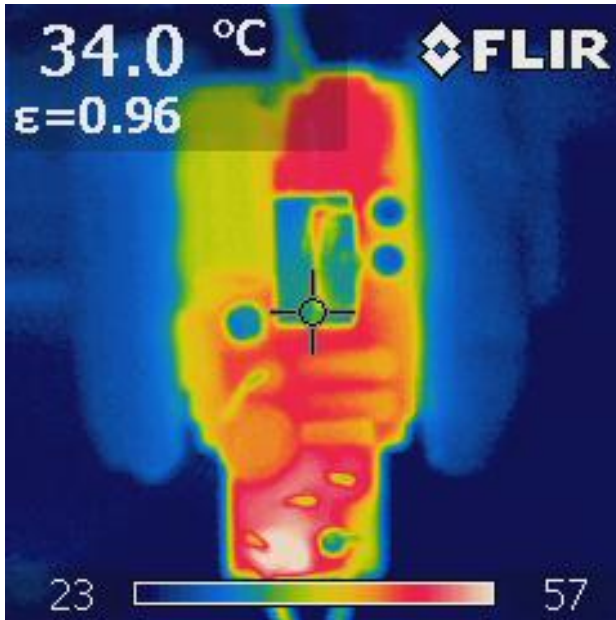


**Figure 21** – Temperature (°C) at Top Side of PCB During Non-dimming Operation at 195 VAC.  
 SP1 – Ambient.  
 SP2 – L1, EMI Choke.  
 SP3 – PCB, Temperature at BR1.  
 SP4 – U1, LYT4322E Without Heat Sink.  
 SP5 – C6, Output Capacitor.  
 SP6 – T1, Power Inductor.

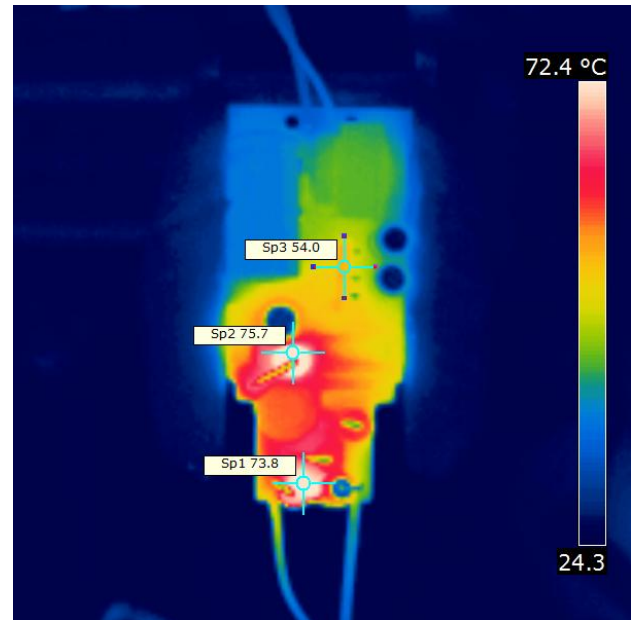


**Figure 22** – Temperature (°C) at Bottom Side of PCB During Non-dimming Operation at 195 VAC.  
 SP1 – Ambient.  
 SP2 – BR1, Bridge Rectifier.  
 SP3 – D5, Blocking Diode.





**Figure 23** – Temperature (°C) at Top Side of PCB During Normal Operation at 195 VAC. SP1 – U1, LYT4322E with Heat Sink.

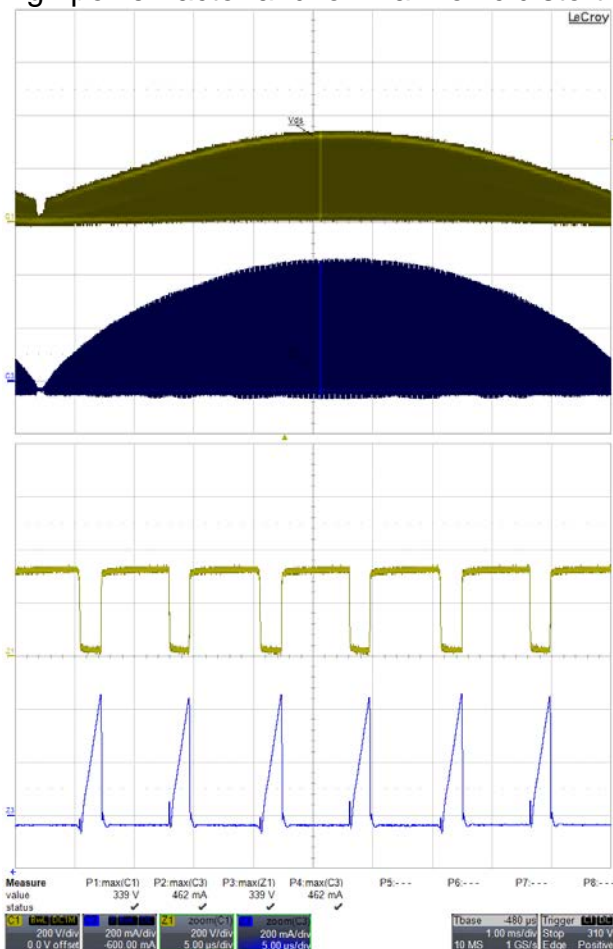


**Figure 24** – Temperature (°C) at Top Side of PCB During Dimming Operation at 240 VAC at 90° Conduction Angle. SP1 – FR2, Damper Resistor. SP2 – R7, Bleeder Resistor. SP3 – U1, LYT4322E Without Heat Sink.

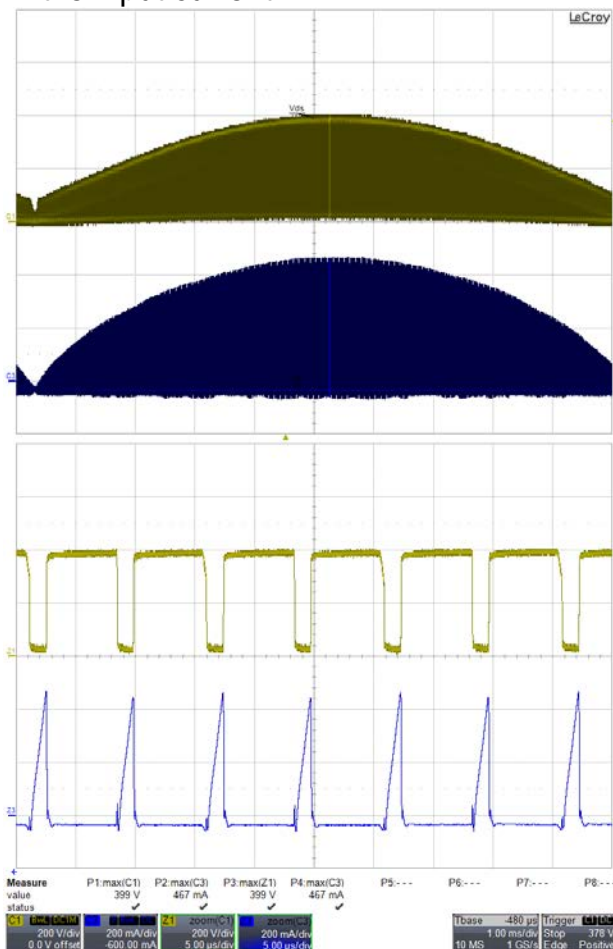
## 12 Waveforms

### 12.1 Drain Voltage, Current Normal Operation

The LYTSwitch-4 optimized in continuous mode operation of inductor current that yields a high power factor and low harmonic distortion in the input current.

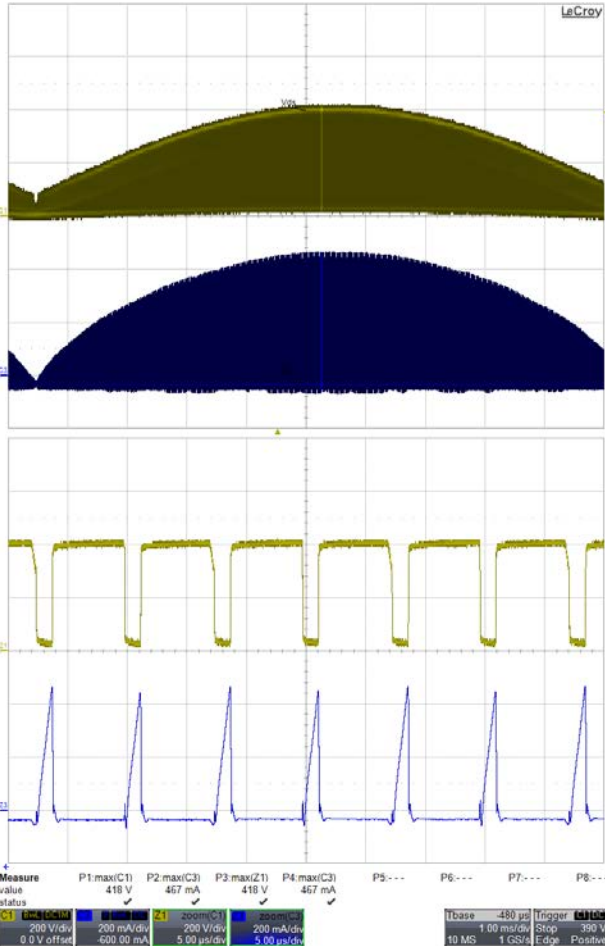


**Figure 25** – 195 VAC, 50 Hz, Nominal  $V_{LED}$  Load.  
 Ch1 (Yellow):  $V_{DRAIN-SOURCE}$ , 200 V / div.  
 Ch3 (Blue):  $I_{DRAIN}$ , 200 mA / div.  
 Time Scale: 1 ms / div.  
 Zoom Time Scale: 5  $\mu$ s / div.

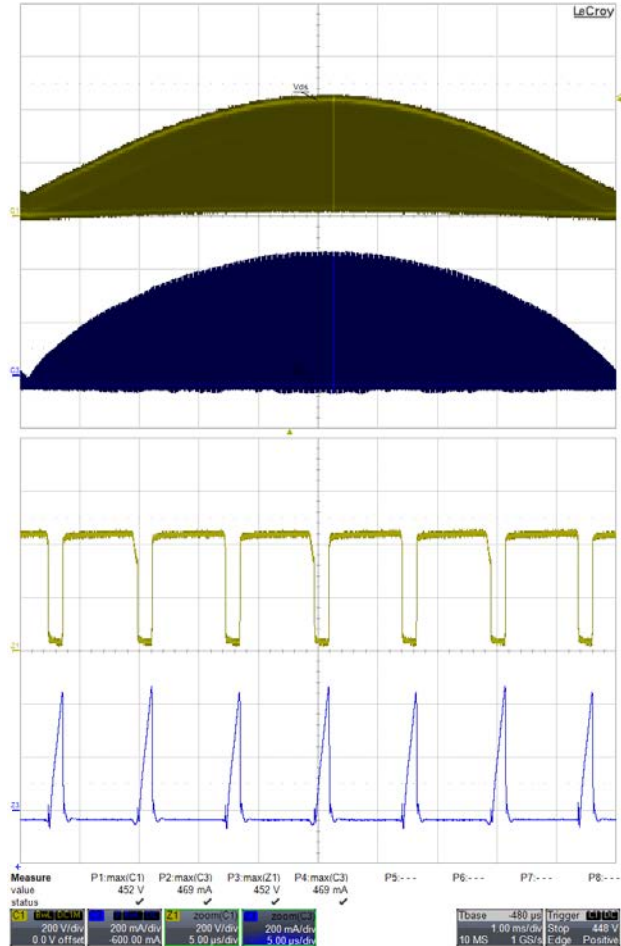


**Figure 26** – 230 VAC, 50 Hz, Nominal  $V_{LED}$  Load.  
 Ch1 (Yellow):  $V_{DRAIN-SOURCE}$ , 200 V / div.  
 Ch3 (Blue):  $I_{DRAIN}$ , 200 mA / div.  
 Time Scale: 1 ms / div.  
 Zoom Time Scale: 5  $\mu$ s / div.





**Figure 27** – 240 VAC, 50Hz, Nominal  $V_{LED}$  Load.  
 Ch1 (Yellow):  $V_{DRAIN-SOURCE}$ , 200 V / div.  
 Ch3 (Blue):  $I_{DRAIN}$ , 200 mA / div.  
 Time Scale: 1 ms / div.  
 Zoom Time Scale: 5  $\mu$ s / div.

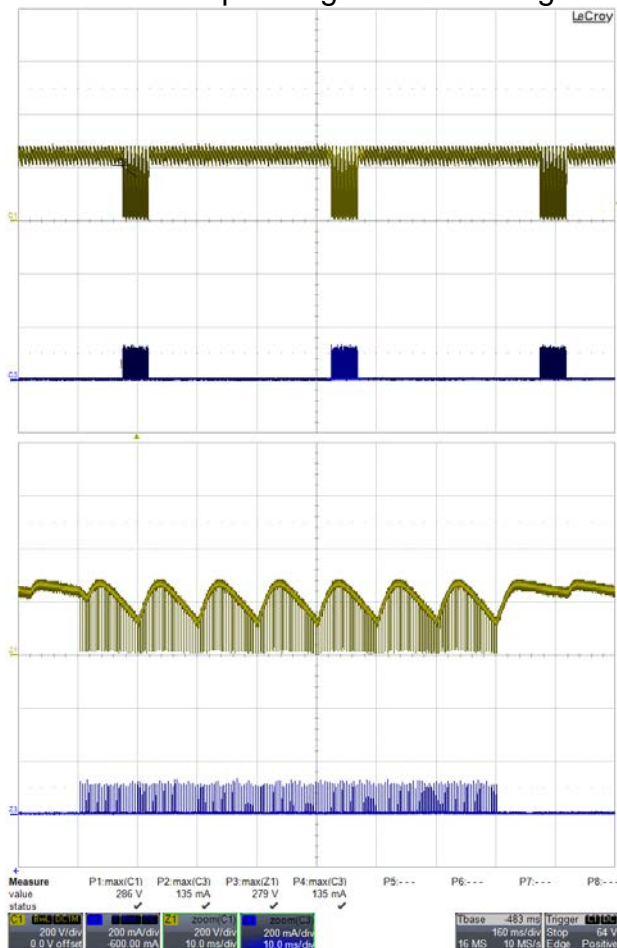


**Figure 28** – 265 VAC, 50Hz, Nominal  $V_{LED}$  Load.  
 Ch1 (Yellow):  $V_{DRAIN-SOURCE}$ , 200 V / div.  
 Ch3 (Blue):  $I_{DRAIN}$ , 200 mA / div.  
 Time Scale: 1 ms / div.  
 Zoom Time Scale: 5  $\mu$ s / div.

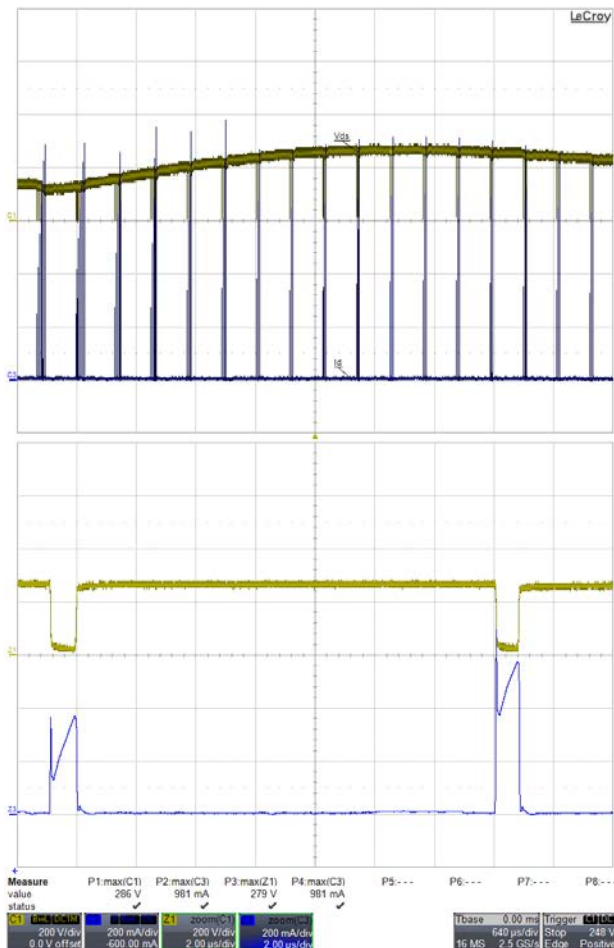


### 12.2 Drain Voltage and Current When Output Short

Device is operating within the range and no inductor saturation was observed.



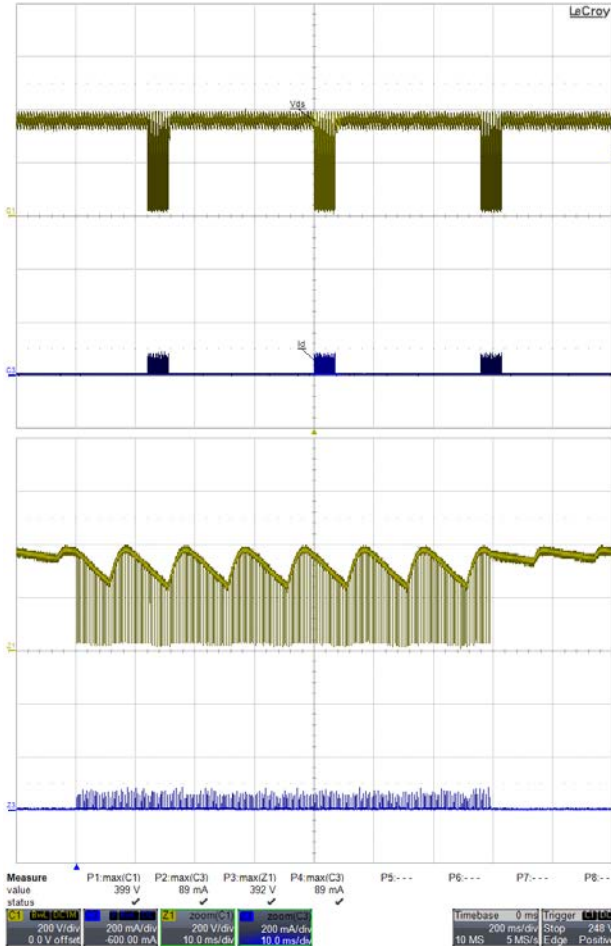
**Figure 29** – LYT4322E Output Short. 195 VAC / 50 Hz.  
 Ch1 (Yellow):  $V_{DRAIN-SOURCE}$ , 200 V / div.  
 Ch3 (Blue):  $I_{DRAIN}$ , 200 mA / div.  
 Time Scale: 160 ms / div.  
 Zoom Time Scale: 10 ms / div.



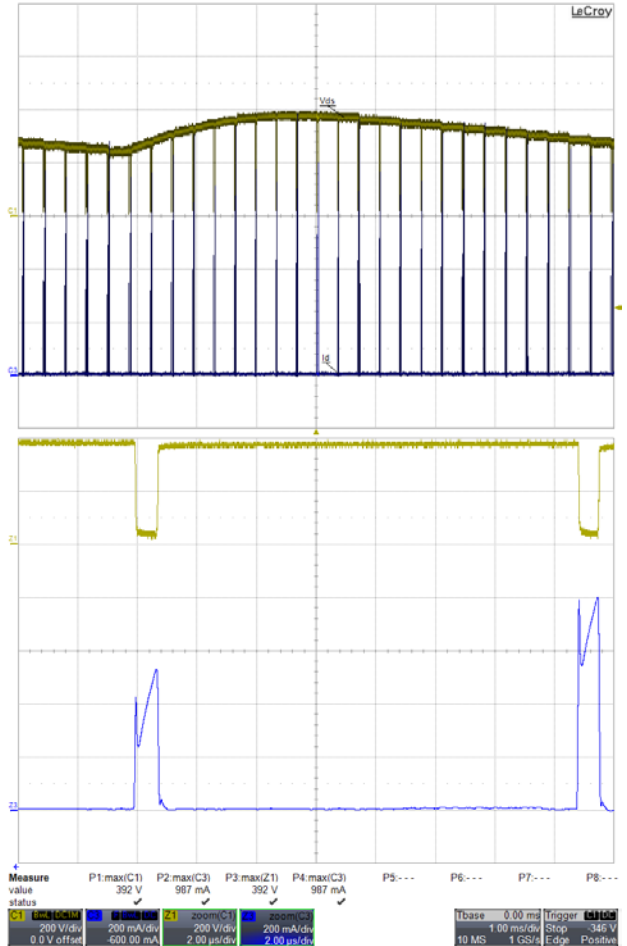
**Figure 30** – LYT4322E Output Short. 195 VAC / 50 Hz.  
 Ch1 (Yellow):  $V_{DRAIN-SOURCE}$ , 200 V / div.  
 Ch3 (Blue):  $I_{DRAIN}$ , 200 mA / div.  
 Time Scale: 640  $\mu$ s / div.  
 Zoom Time Scale: 2  $\mu$ s / div.







**Figure 31** – LYT4322E Output Short. 265 VAC / 50 Hz.  
 Ch1 (Yellow):  $V_{DRAIN-SOURCE}$ , 200 V / div.  
 Ch3 (Blue):  $I_{DRAIN}$ , 200 mA / div.  
 Time Scale: 200 ms / div.  
 Zoom Time Scale: 10 ms / div

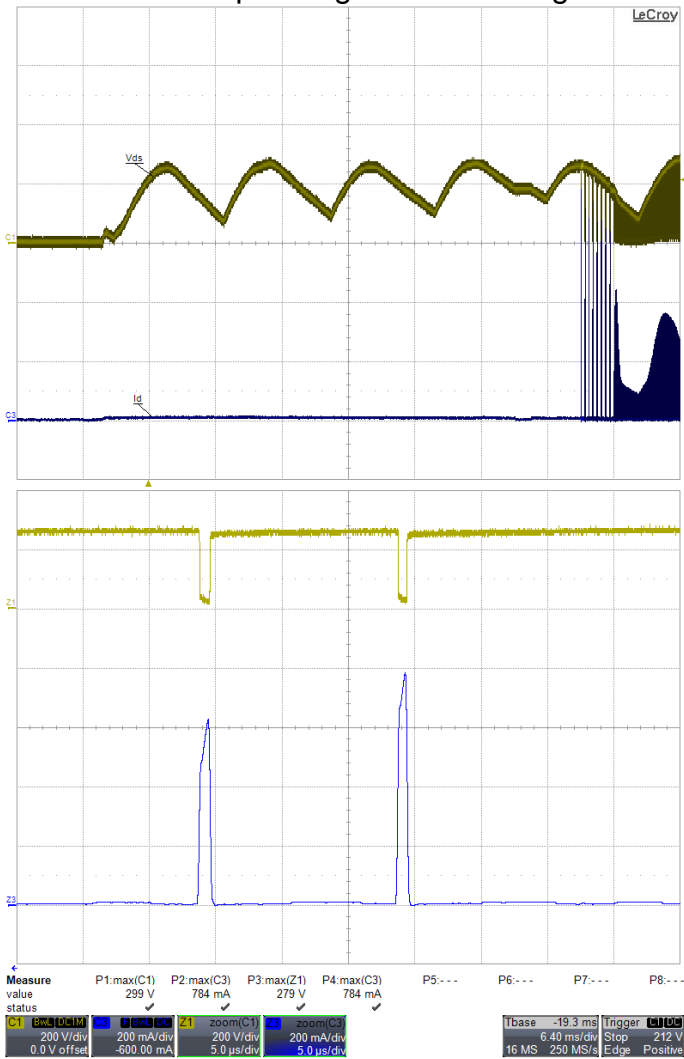


**Figure 32** – LYT4322E Output Short. 195 VAC / 50 Hz.  
 Ch1 (Yellow):  $V_{DRAIN-SOURCE}$ , 200 V / div.  
 Ch3 (Blue):  $I_{DRAIN}$ , 200 mA / div.  
 Time Scale: 1ms / div. Zoom  
 Time Scale: 2  $\mu$ s / div



### 12.3 Drain Voltage and Current Start-up Profile

Device is operating within the range and no inductor saturation was observed.



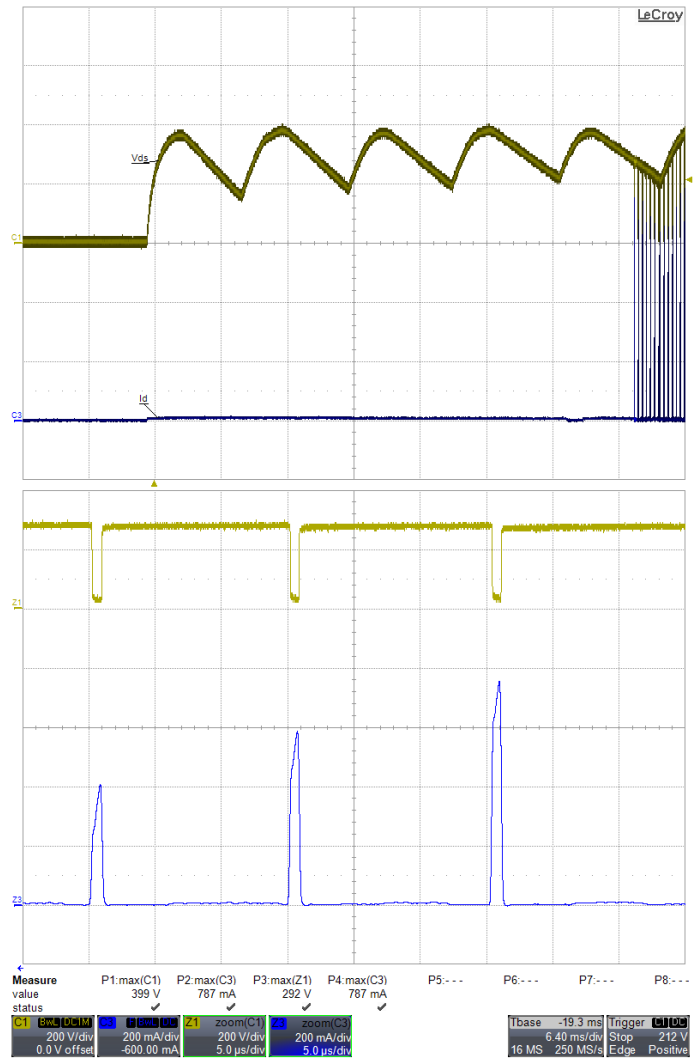
**Figure 33 – 195 VAC / 50 Hz Start-up.**

Ch1 (Yellow):  $V_{DRAIN-SOURCE}$ , 200 V / div.

Ch3 (Blue):  $I_{DRAIN}$ , 200 mA / div.

Time Scale: 1 ms / div.

Zoom Time Scale: 5  $\mu$ s / div.



**Figure 34 – 265 VAC / 50 Hz Start-up.**

Ch1 (Yellow):  $V_{DRAIN-SOURCE}$ , 200 V / div.

Ch3 (Blue):  $I_{DRAIN}$ , 200 mA / div.

Time Scale: 1 ms / div.

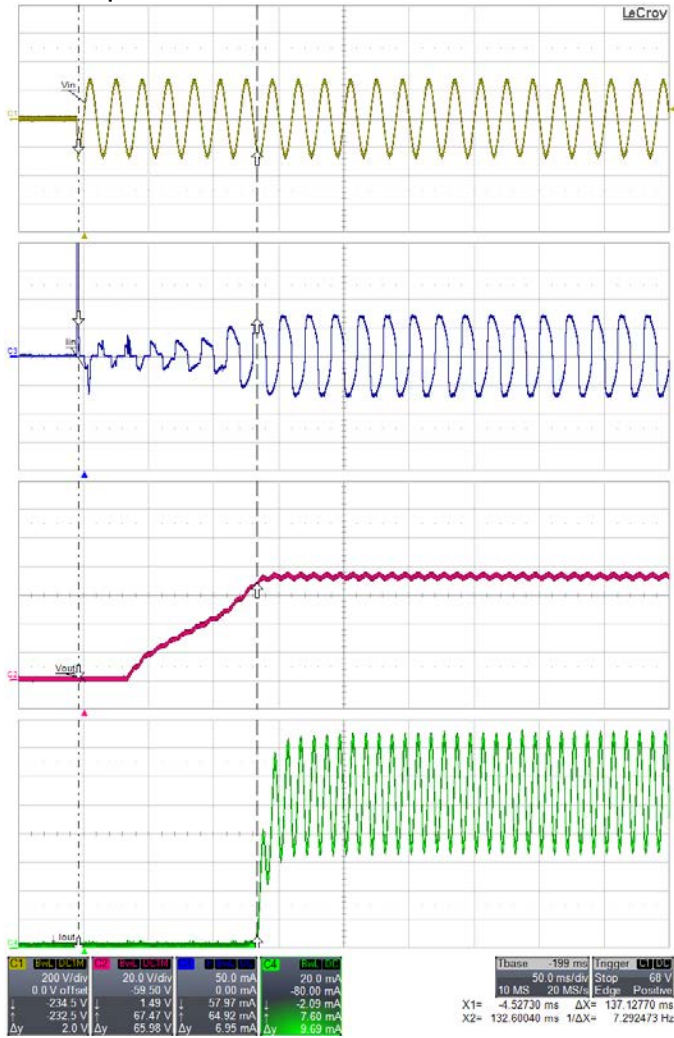
Zoom Time Scale: 5  $\mu$ s / div.



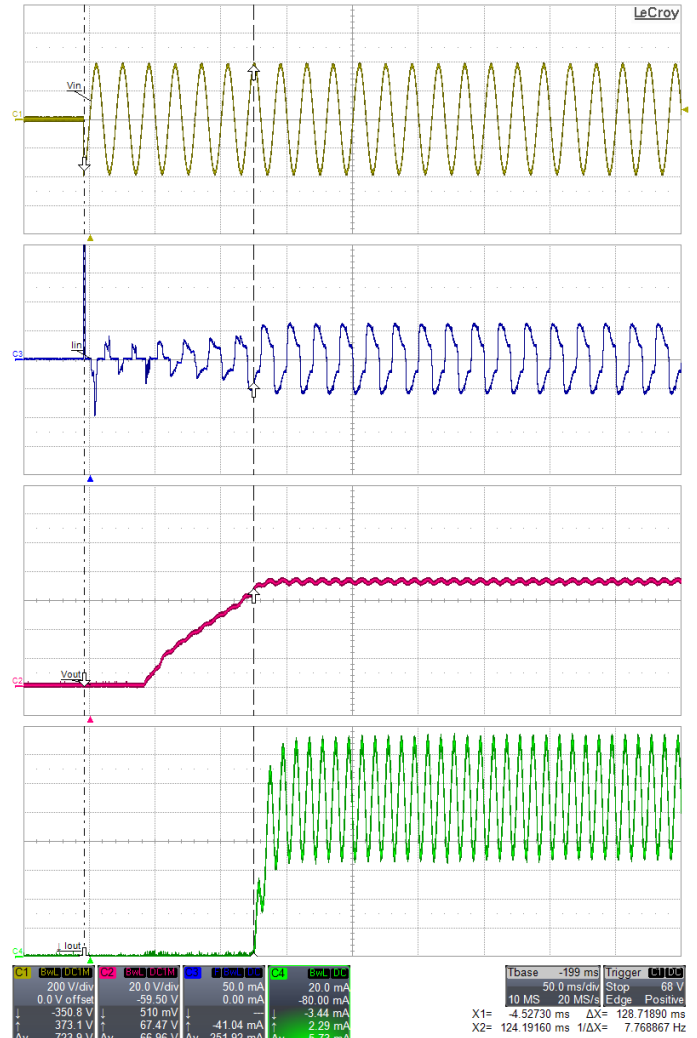


### 12.4 Output Current Start-up Profile

Output current is available in <150 ms.



**Figure 35** – 195 VAC, 50 Hz, Nominal  $V_{LED}$  Load.  
 Ch1 (Yellow):  $V_{IN}$ , 200 V / div.  
 Ch2 (Red):  $V_{OUT}$ , 20 V.  
 Ch3 (Blue):  $I_{IN}$ , 50 mA / div.  
 Ch4 (Green):  $I_{OUT}$ , 20 mA / div.  
 Time Scale: 20 ms / div.

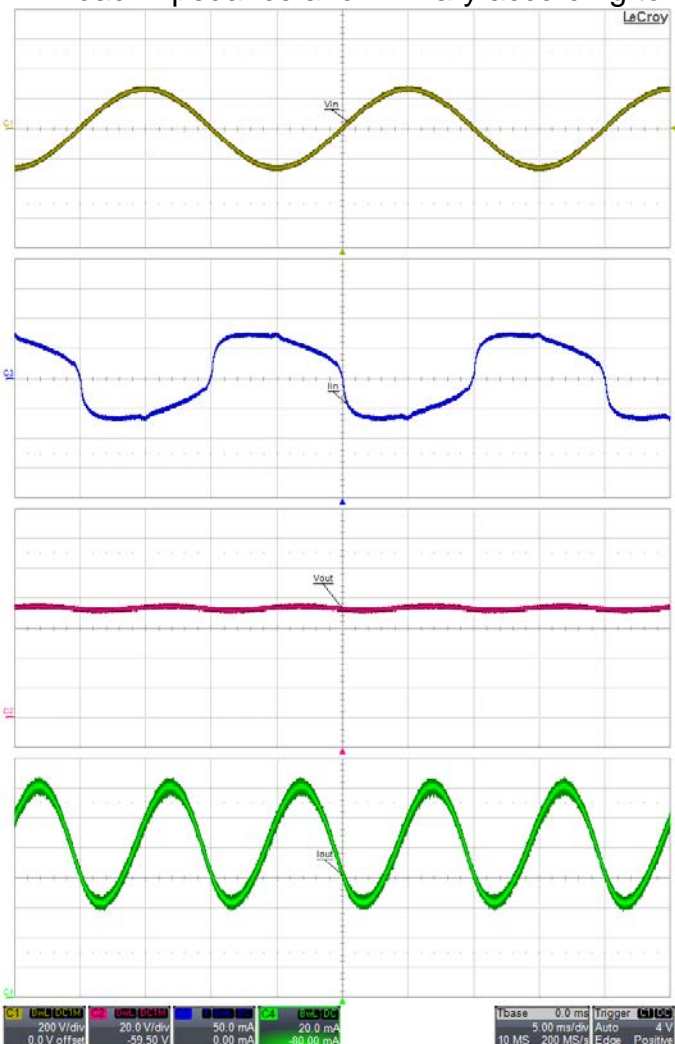


**Figure 36** – 265 VAC, 50 Hz, Nominal  $V_{LED}$  Load.  
 Ch1 (Yellow):  $V_{IN}$ , 200 V / div.  
 Ch2 (Red):  $V_{OUT}$ , 20 V.  
 Ch3 (Blue):  $I_{IN}$ , 50 mA / div.  
 Ch4 (Green):  $I_{OUT}$ , 20 mA / div.  
 Time Scale: 20 ms / div.



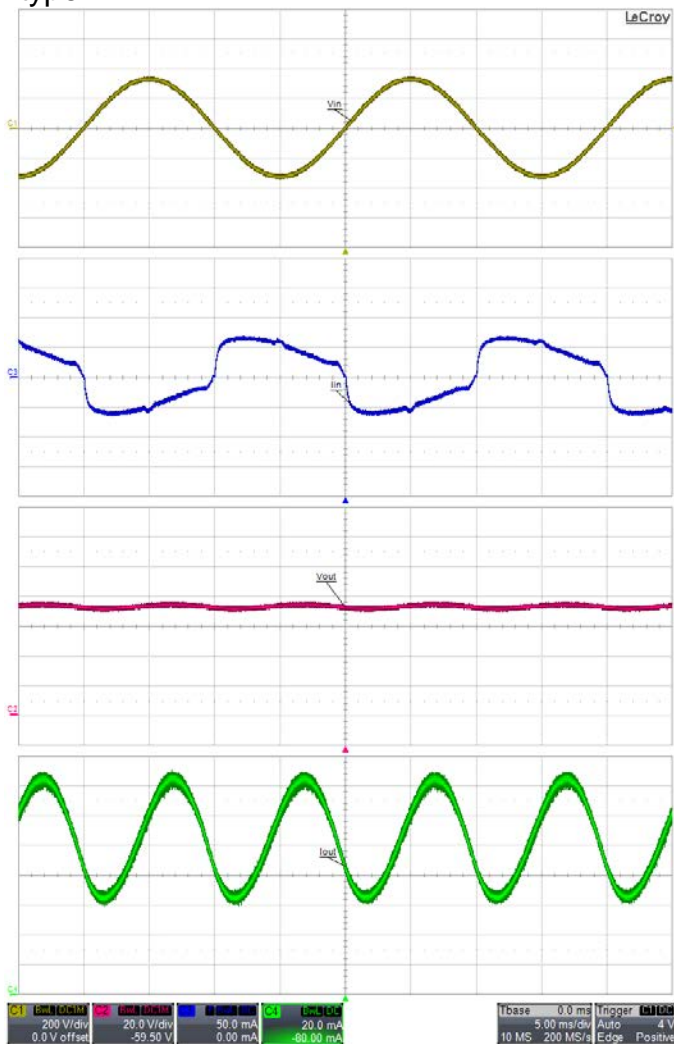
### 12.5 Input-Output Profile

There is no limitation to the amount of output capacitance that can be added. If the application requires less output current ripple then increasing the output capacitance is straight forward. Note that the output current waveform below will vary depending on LED load impedance and will vary according to LED type.



**Figure 37** – 195 VAC / 50 Hz, Nominal  $V_{LED}$  Load.

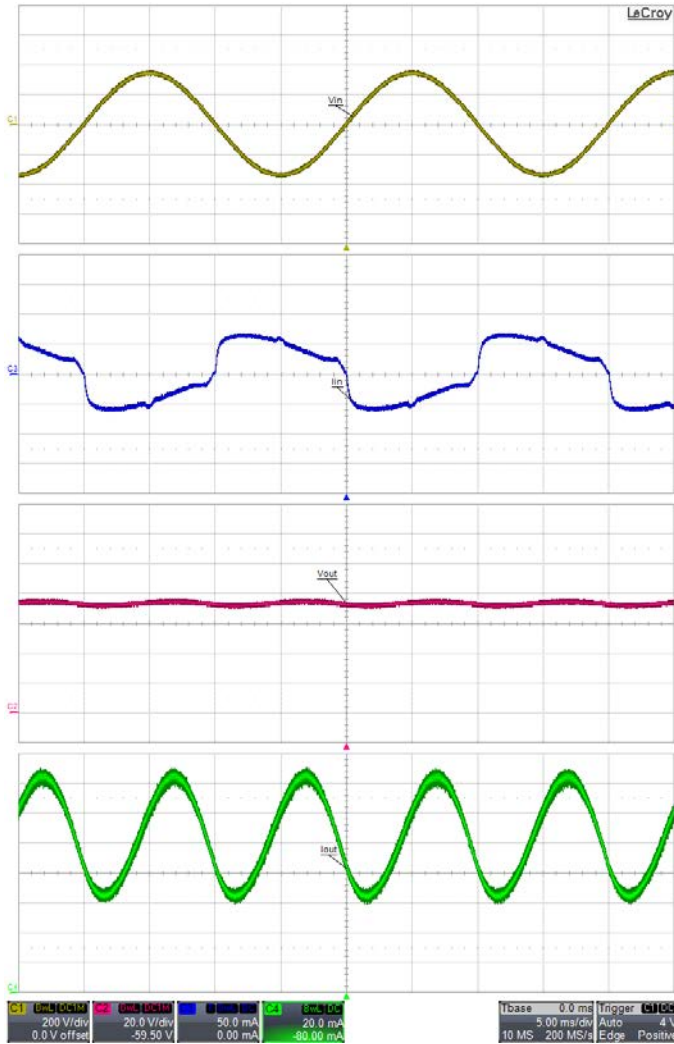
Ch1 (Yellow):  $V_{IN}$ , 200 V / div.  
 Ch2 (Red):  $V_{OUT}$ , 20 V.  
 Ch3 (Blue):  $I_{IN}$ , 50 mA / div.  
 Ch4 (Green):  $I_{OUT}$ , 20 mA / div,  
 Time Scale: 5 ms / div.



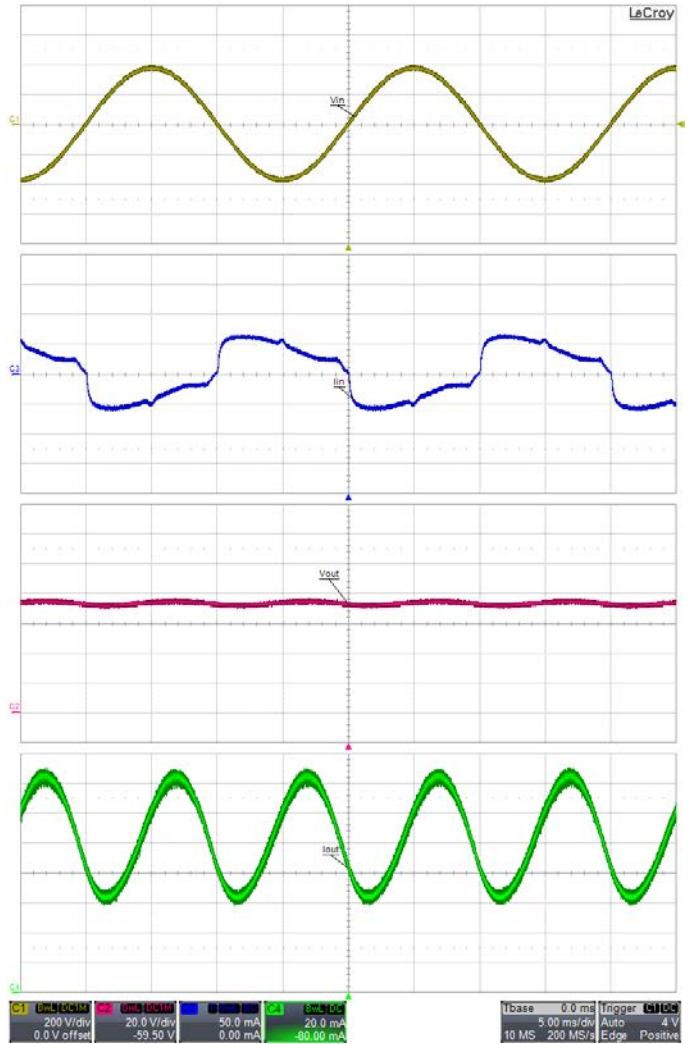
**Figure 38** – 230 VAC / 50 Hz, Nominal  $V_{LED}$  Load.

Ch1 (Yellow):  $V_{IN}$ , 200 V / div.  
 Ch2 (Red):  $V_{OUT}$ , 20 V.  
 Ch3 (Blue):  $I_{IN}$ , 50 mA / div.  
 Ch4 (Green):  $I_{OUT}$ , 20 mA / div,  
 Time Scale: 5 ms / div.





**Figure 39** – 240 VAC / 50 Hz, Nominal  $V_{LED}$  Load.  
 Ch1 (Yellow):  $V_{IN}$ , 200 V / div.  
 Ch2 (Red):  $V_{OUT}$ , 20 V.  
 Ch3 (Blue):  $I_{IN}$ , 50 mA / div.  
 Ch4 (Green):  $I_{OUT}$ , 20 mA / div.  
 Time Scale: 5 ms / div.

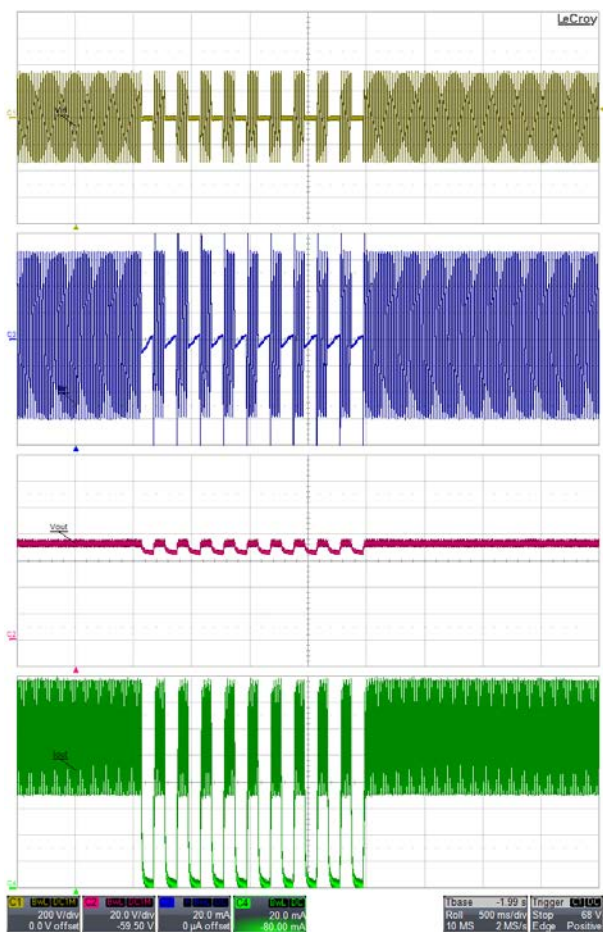


**Figure 40** – 265 VAC / 50 Hz, Nominal  $V_{LED}$  Load.  
 Ch1 (Yellow):  $V_{IN}$ , 200 V / div.  
 Ch2 (Red):  $V_{OUT}$ , 20 V.  
 Ch3 (Blue):  $I_{IN}$ , 50 mA / div.  
 Ch4 (Green):  $I_{OUT}$ , 20 mA / div.  
 Time Scale: 5 ms / div.

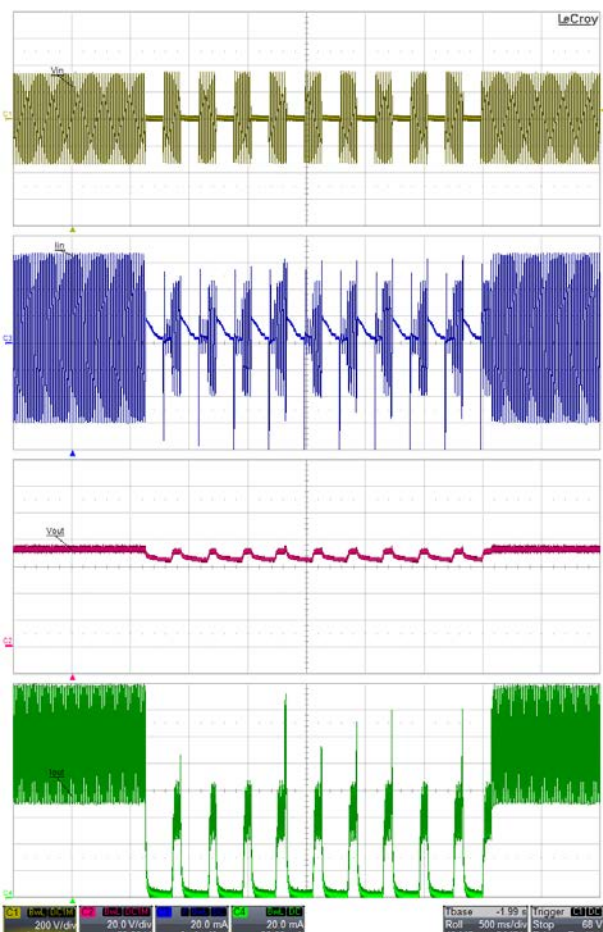


### 12.6 Line Sag and Surge

The inherent advantage of the buck converter implemented with LYTSwitch-4 is the imperceptible start-up delay, the driver will turn-on within 100 ms as shown in the figures below. No failure of any component occurred during Line fluctuation tests.



**Figure 41 – Line Sag Test at 230 - 0 V at 0.1 sec Interval.**  
 Ch1:  $V_{IN}$ ; 200 V / div.  
 Ch2:  $V_{OUT}$ ; 20 V / div.  
 Ch3:  $I_{IN}$ ; 20 mA / div  
 Ch4:  $I_{OUT}$ ; 20 mA / div.  
 Time Scale: 500 ms / div.

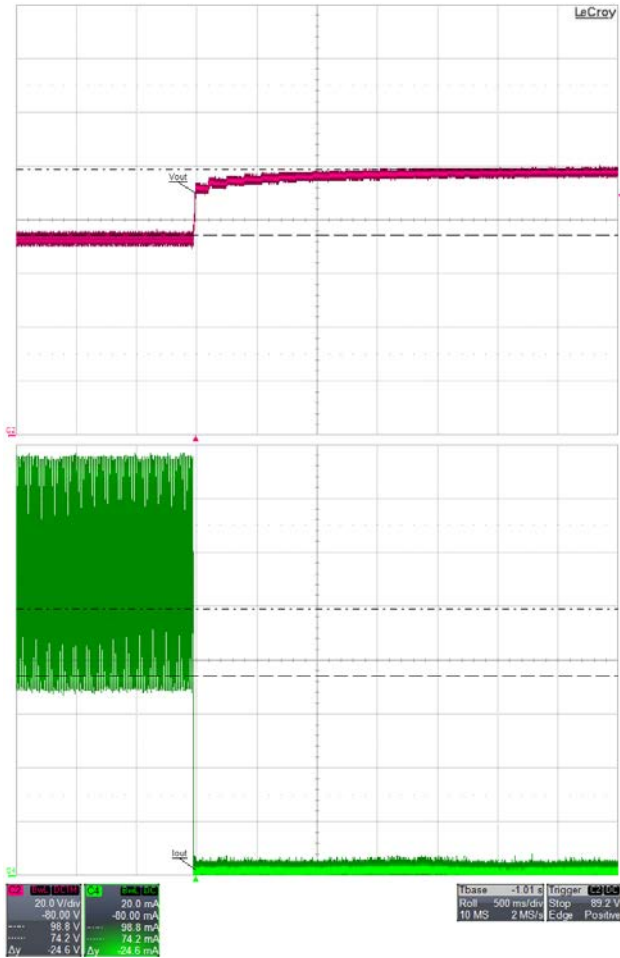


**Figure 42 – Line Surge Test at 230 - 0 at 0.15 sec Interval.**  
 Ch1:  $V_{IN}$ ; 200 V / div.  
 Ch2:  $V_{OUT}$ ; 20 V / div.  
 Ch3:  $I_{IN}$ ; 20 mA / div  
 Ch4:  $I_{OUT}$ ; 20 mA / div.  
 Time Scale: 500 ms / div.

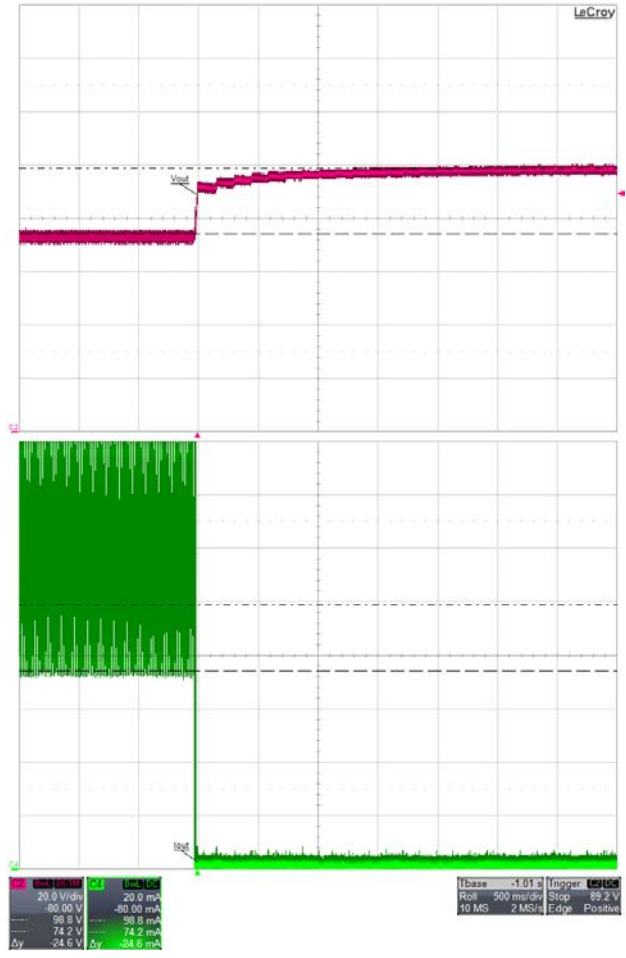




**12.7 No-Load Protection**

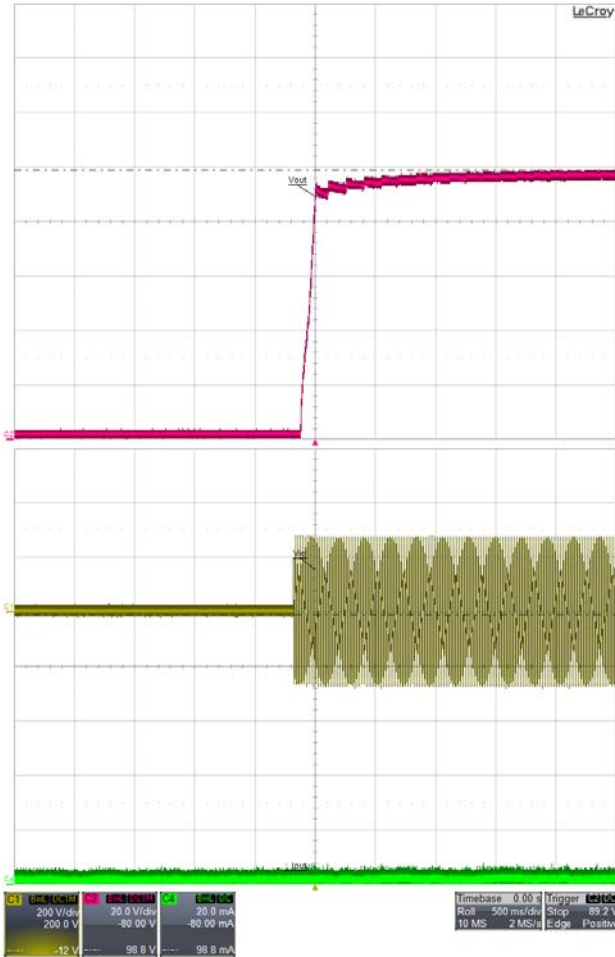


**Figure 43** – No-load Protection when Load is Disconnected. 195 V / 50 Hz.  
 Ch2:  $V_{OUT}$ ; 20 V / div.  
 Ch3:  $I_{OUT}$ ; 50 mA / div.  
 Time Scale: 500 ms / div.

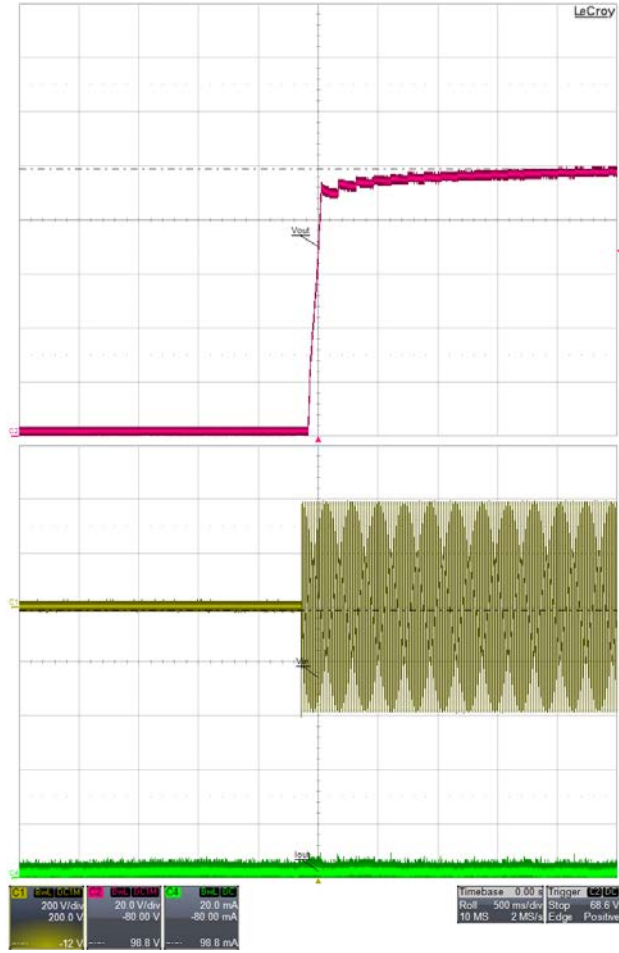


**Figure 44** – No-load Protection when Load is Disconnected. 265 V / 50 Hz.  
 Ch2:  $V_{OUT}$ ; 20 V / div.  
 Ch3:  $I_{OUT}$ ; 50 mA / div.  
 Time Scale: 500 ms / div.





**Figure 45** – No-load Start-up. 195 V / 50 Hz.  
Ch2:  $V_{OUT}$ ; 20 V / div.  
Ch3:  $I_{OUT}$ ; 50 mA / div.  
Time Scale: 500 ms / div.

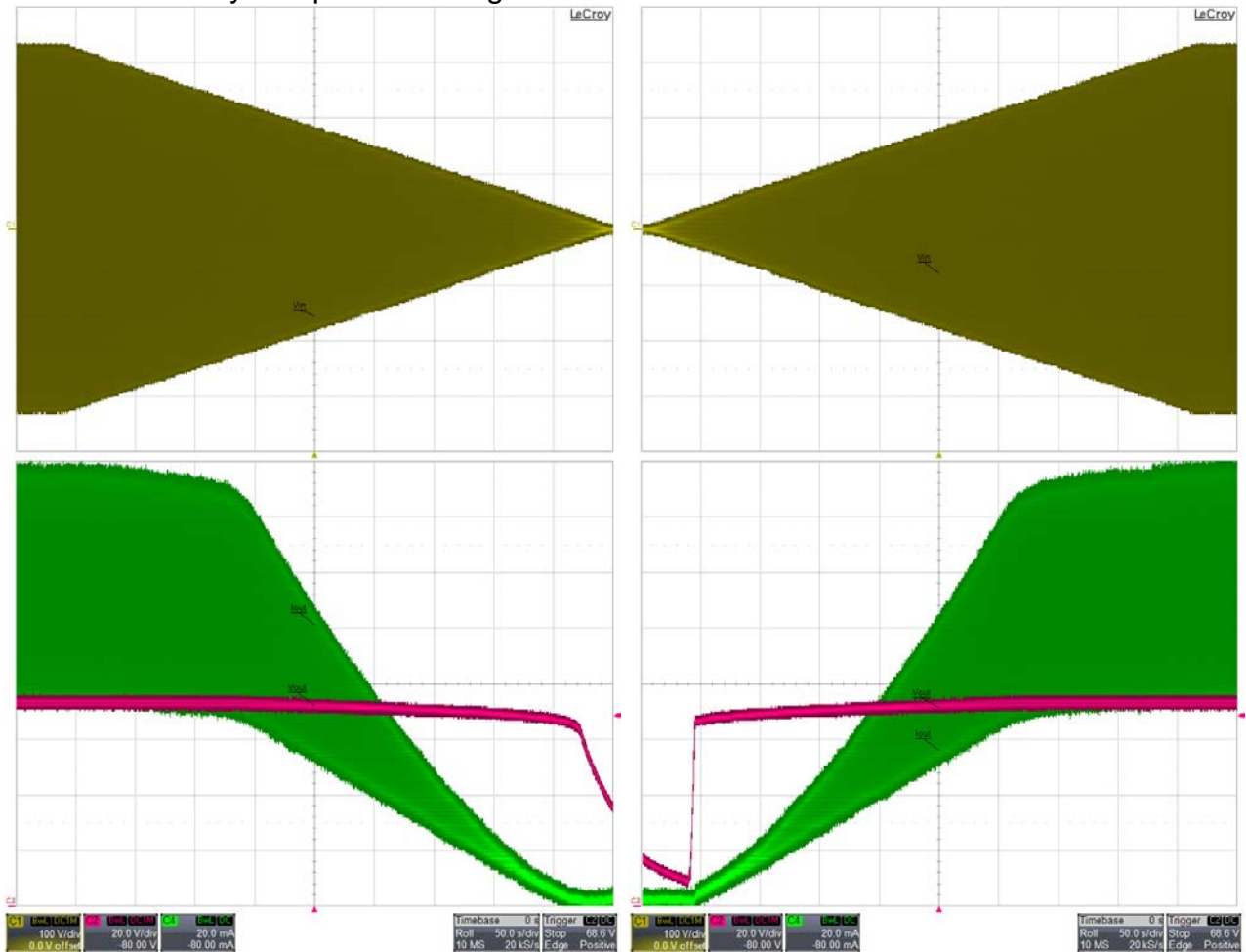


**Figure 46** – No-load Start-up. 265 V / 50 Hz.  
Ch2:  $V_{OUT}$ ; 20 V / div.  
Ch3:  $I_{OUT}$ ; 50 mA / div.  
Time Scale: 500 ms / div.



## 12.8 Brown-out/ Brown-in

No failure of any component during brownout test of 0.5V / sec.



**Figure 47** – Brown-out Test at 0.5 V / s. The Unit is Able to Operate Normally Without Any Failure and Without Flicker.  
 230 V-0-230 V  
 Ch1: V<sub>IN</sub>; 100 V / div.  
 Ch2: V<sub>OUT</sub>; 20 V / div.  
 Ch3: I<sub>OUT</sub>; 20 mA / div.  
 Time Scale: 50 s / div.

**Figure 48** – Brown-out Test at 0.5 V / s. The Unit is Able to Operate Normally Without Any Failure and Without Flicker.  
 230 V-0-230 V  
 Ch1: V<sub>IN</sub>; 100 V / div.  
 Ch2: V<sub>OUT</sub>; 20 V / div.  
 Ch3: I<sub>OUT</sub>; 20 mA / div.  
 Time Scale: 50 s / div.



### 13 Dimming

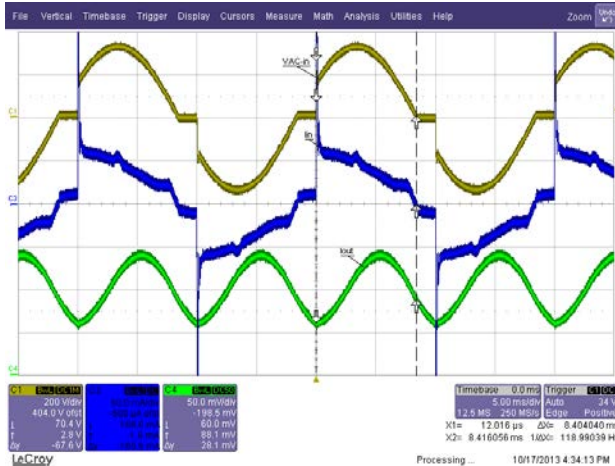
#### 13.1 Dimming compatibility

List of Dimmers	Type	Max Iout	Min Iout	Ratio	Conduction Time (mS)				Compatibility
					Regulated AC Line		Distorted AC Line		
					Min	Max	Min	Max	
Berker KOPP 8033	L	102	16.37	6.23	7.64	2.54	7.51	1.95	Pass
Busch 6591-101	T	107.9	22.66	4.76	6.87	2.08	7.58	2.54	Pass
Busch 6513 U-102	T	110.9	24.74	4.48	7.64	2.02	7.97	2.28	Pass
PEHA 433HAB 0A	T	106.1	34.9	3.04	7.58	3.25	7.39	3.25	Pass
PEHA 433HAB 0A	T	99.2	19.56	5.07	6.93	2.6	7.06	2.6	Pass
Busch 2250	L	110.7	12.2	9.07	8.6	2.46	8.34	2.22	Pass
PEHA 400W	L	102.7	0.087	1180.46	7.91	0.73	7.58	0.606	Pass
Merten 572499	L	113.5	8.08	14.05	9.01	1.9	8.69	1.71	Pass
Busch 6513	T	110.8	25.07	4.42	7.91	1.9	7.91	2.35	Pass
Berker 2875	L	109.4	17.23	6.35	8.29	2.53	8.02	2.14	Pass
Berker 2830 10	L	104.7	26.19	4.00	8.4	3.37	8.25	3.04	Pass
Jung 225 NV DE	L	104.4	22.94	4.55	8.37	2.98	8.04	2.49	Pass
Jung 254 UDIE 1	T	104.8	31.1	3.37	7.67	2.65	7.78	2.65	Pass
Jung 266 G DE	L	105.9	24.27	4.36	8.6	3.16	8.45	2.8	Pass
Busch 2200 UJ-212	L	105.4	32.8	3.21	8.61	3.62	8.42	3.56	Pass
Busch 2250 U	L	106.3	24.95	4.26	8.64	3.29	8.28	2.81	Pass
Busch 2247 U	L	105.3	30.13	3.49	8.524	3.74	8.21	3.4	Pass
Gira 2262 00 I01	L	105.5	19.33	5.46	8.33	2.75	8.21	2.12	Pass
Busch 2247 U	L	105.2	28.87	3.64	8.39	3.45	8.02	3	Pass
Busch 2250 U	L	107.4	19.74	5.44	8.55	2.45	8.34	2.28	Pass
GIRA 1176 00 I03	T	103.4	30.2	3.42	7.06	2.27	7.56	2.51	Pass
Niko 310-013	L	108.9	27.61	3.94	8.79	3.29	8.35	2.85	Pass
Niko 310-017	T	99.8	33.8	2.95	7.21	3	7.44	3.24	Pass
Niko 310-014	L	108.7	33	3.29	8.76	3.78	8.49	3.45	Pass
Niko 310-016	L	107.6	29.91	3.60	8.3	3.44	8.3	2.93	Slight Shimmer for Distorted Line
Relco RM34DMA	L	113.6	24	4.73	8.87	2.79	8.81	2.59	Pass
Relco RTM34LED DAXS	L	95.1	9.37	10.15	7.18	2.08	7.12	2.08	Pass
Relco RM34DMA	L	115	22.22	5.18	9.13	3.11	9.18	2.46	Pass
Relco RTS34.43 RLI	L	114.6	3.77	30.40	9.26	1.5	9.06	1.75	Pass
Relco RT34DSL	L	115	20.48	5.62	9.26	2.85	9.13	2.53	Pass
TCL	L	109.5	11.85	9.24	9.23	2.12	9.04	1.67	Pass
SEN BO LANG	L	109.5	29.56	3.70	9.3	3.42	8.98	2.83	Pass
EBA HUANG	L	109.5	1.58	69.30	9.3	1.09	9.05	1.09	Pass
SB ELECT	L	107.1	1.78	60.17	8.47	0.906	8.08	0.38	Pass
MYONGBO	L	109.6	28.41	3.86	9.32	3.11	9.121	2.84	Pass
KBE	L	109	0.7	155.71	8.99	1.14	8.86	0.68	Pass
CLIPMEI	L	109.1	10.9	10.01	9.09	2.17	9.035	1.69	Pass
MANK	L	109.5	31.8	3.44	9.26	3.5	9.13	3.11	Pass
Clipsal 32E450LM	L	104.4	12.77	8.18	7.96	2.2	7.42	2.01	Pass
Clipsal 32E450TM	T	108.2	16.83	6.43	7.9	2.47	8.03	2.47	Pass
Clipsal 32E2CFLDM	T	106.6	16.14	6.60	7.53	2.28	7.94	2.44	Pass
Clipsal 32E450UDM	T	112	21.19	5.29	8.04	2.61	8.3	2.87	Pass

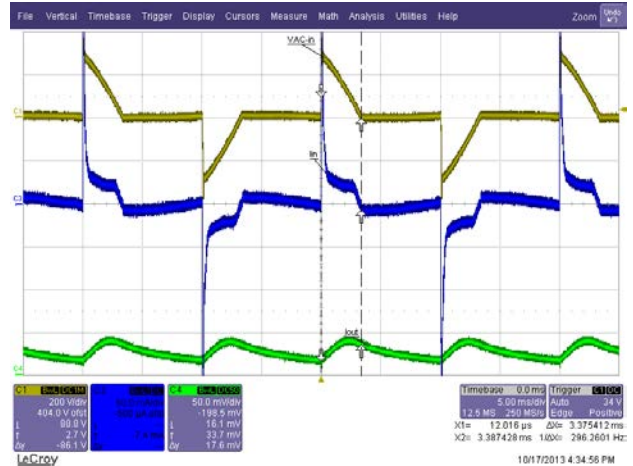


### 13.2 Dimming Waveforms

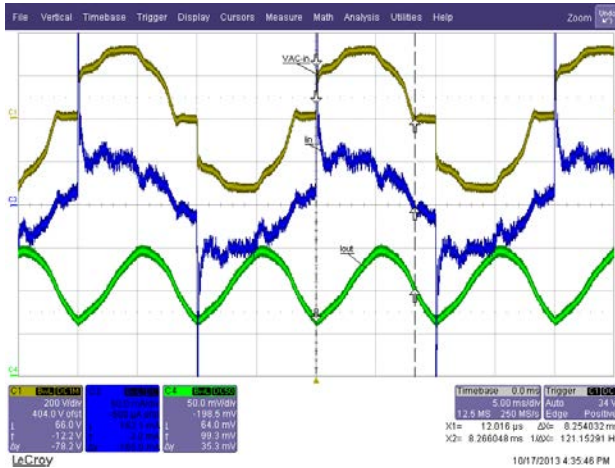
Dimmer: Berker 2830 10



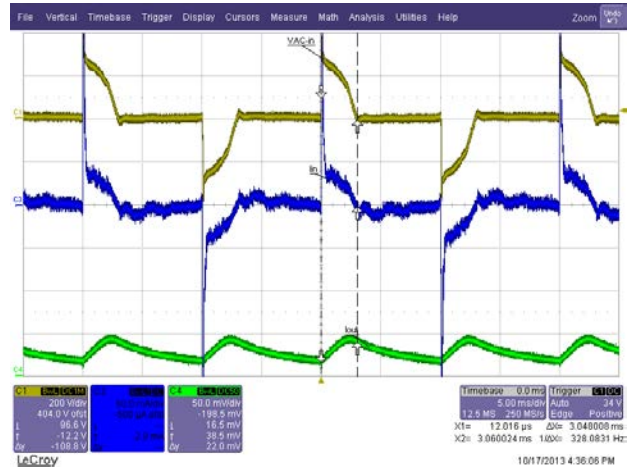
**Figure 49** – Full Conduction from Regulated AC Input 230 V / 50 Hz.  
 Ch1: V<sub>IN</sub>; 200 V / div.  
 Ch3: I<sub>IN</sub>; 50 mA / div.  
 Ch4: I<sub>OUT</sub>; 50 mA / div.  
 Time Scale: 5 ms / div.



**Figure 50** – Minimum Conduction from Regulated AC Input 230 V / 50 Hz.  
 Ch1: V<sub>IN</sub>; 200 V / div.  
 Ch3: I<sub>IN</sub>; 50 mA / div.  
 Ch4: I<sub>OUT</sub>; 50 mA / div.  
 Time Scale: 5 ms / div.



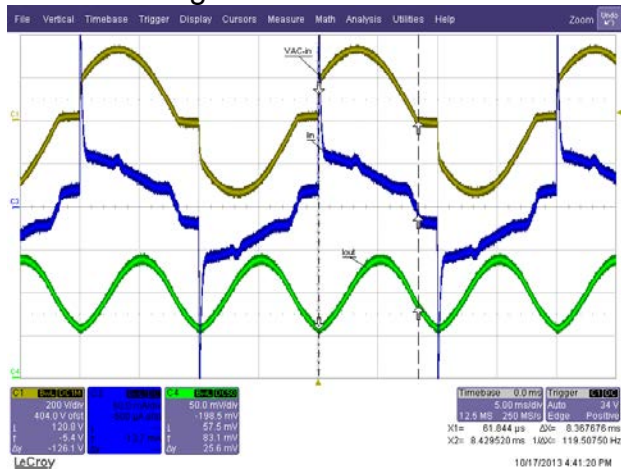
**Figure 51** – Full Conduction from Distorted AC Line 230 V / 50 Hz.  
 Ch1: V<sub>IN</sub>; 200 V / div.  
 Ch3: I<sub>IN</sub>; 50 mA / div.  
 Ch4: I<sub>OUT</sub>; 50 mA / div.  
 Time Scale: 5 ms / div.



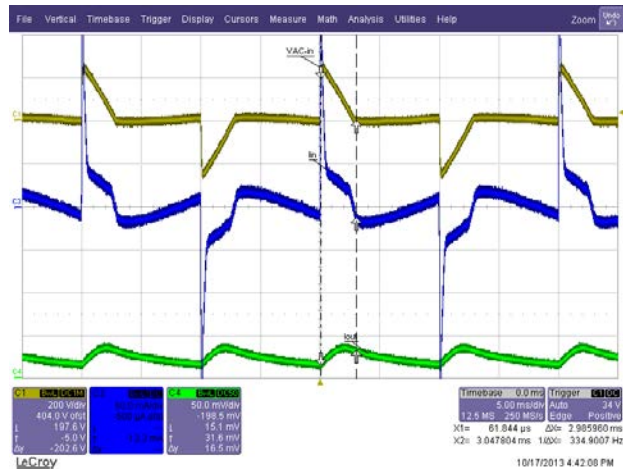
**Figure 52** – Minimum Conduction from Distorted AC Line 230 V / 50 Hz.  
 Ch1: V<sub>IN</sub>; 200 V / div.  
 Ch3: I<sub>IN</sub>; 50 mA / div.  
 Ch4: I<sub>OUT</sub>; 50 mA / div.  
 Time Scale: 5 ms / div.



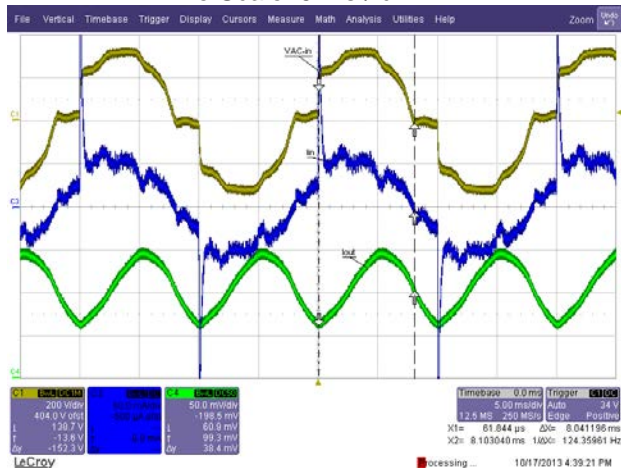
Dimmer: Jung 225 NV DE



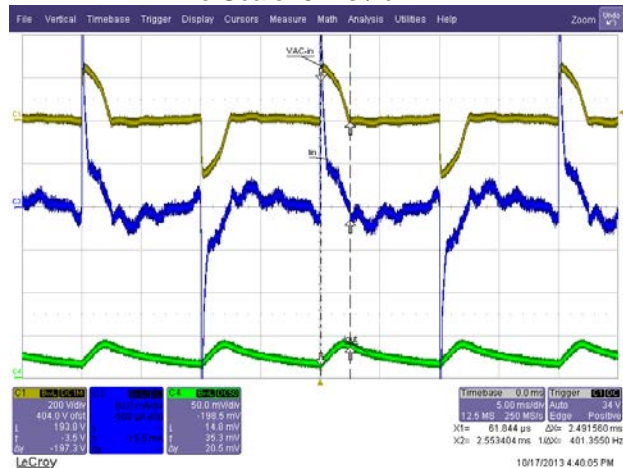
**Figure 53** – Full Conduction from Regulated AC Input 230 V / 50 Hz.  
 Ch1:  $V_{IN}$ ; 200 V / div.  
 Ch3:  $I_{IN}$ ; 50 mA / div.  
 Ch4:  $I_{OUT}$ ; 50 mA / div.  
 Time Scale: 5 ms / div.



**Figure 54** – Minimum Conduction from Regulated AC Input 230 V / 50 Hz.  
 Ch1:  $V_{IN}$ ; 200 V / div.  
 Ch3:  $I_{IN}$ ; 50 mA / div.  
 Ch4:  $I_{OUT}$ ; 50 mA / div.  
 Time Scale: 5 ms / div.



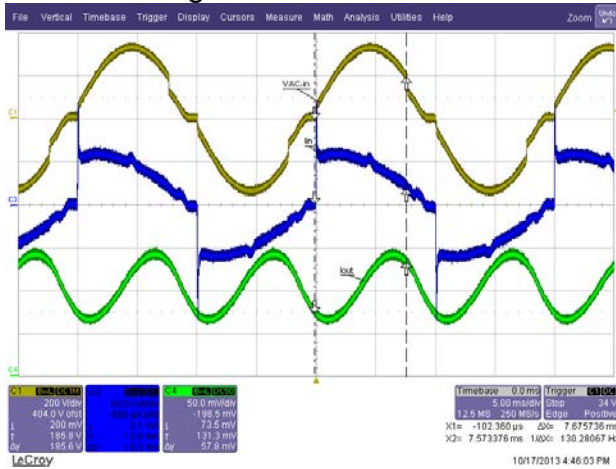
**Figure 55** – Full Conduction from Distorted AC Line 230 V / 50 Hz.  
 Ch1:  $V_{IN}$ ; 200 V / div.  
 Ch3:  $I_{IN}$ ; 50 mA / div.  
 Ch4:  $I_{OUT}$ ; 50 mA / div.  
 Time Scale: 5 ms / div.



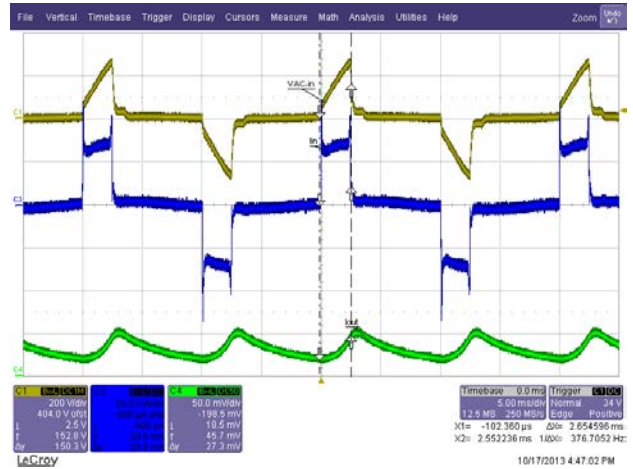
**Figure 56** – Minimum Conduction from Distorted AC Line 230 V / 50 Hz.  
 Ch1:  $V_{IN}$ ; 200 V / div.  
 Ch3:  $I_{IN}$ ; 50 mA / div.  
 Ch4:  $I_{OUT}$ ; 50 mA / div.  
 Time Scale: 5 ms / div.



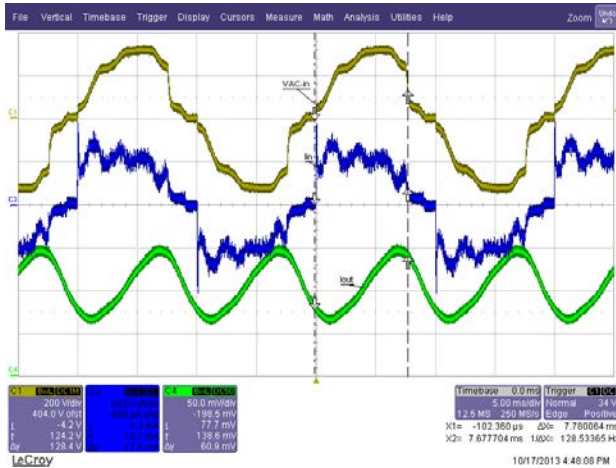
Dimmer: Jung 254 UDIE 1



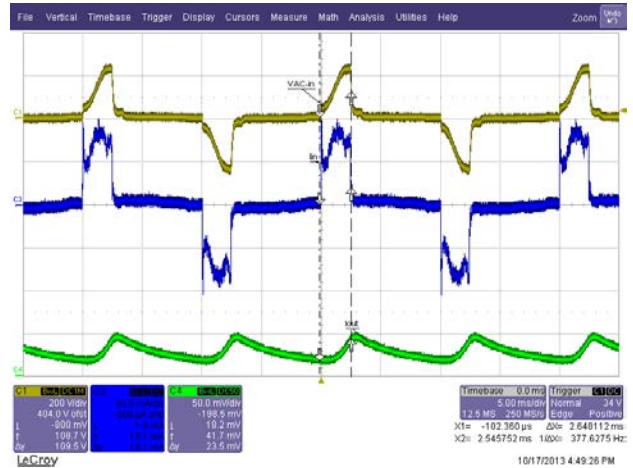
**Figure 57** – Full Conduction from Regulated AC Input 230 V / 50 Hz.  
 Ch1: V<sub>IN</sub>; 200 V / div.  
 Ch3: I<sub>IN</sub>; 50 mA / div.  
 Ch4: I<sub>OUT</sub>; 50 mA / div.  
 Time Scale: 5 ms / div.



**Figure 58** – Minimum Conduction from Regulated AC Input 230 V / 50 Hz.  
 Ch1: V<sub>IN</sub>; 200 V / div.  
 Ch3: I<sub>IN</sub>; 50 mA / div.  
 Ch4: I<sub>OUT</sub>; 50 mA / div.  
 Time Scale: 5 ms / div.



**Figure 59** – Full Conduction from Distorted AC Line 230 V / 50 Hz.  
 Ch1: V<sub>IN</sub>; 200 V / div.  
 Ch3: I<sub>IN</sub>; 50 mA / div.  
 Ch4: I<sub>OUT</sub>; 50 mA / div.  
 Time Scale: 5 ms / div.

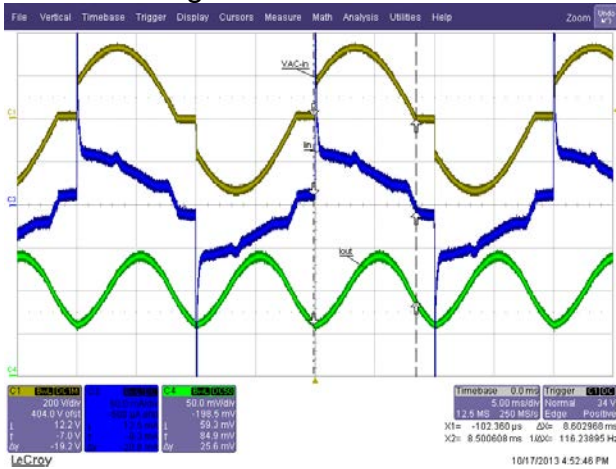


**Figure 60** – Minimum Conduction from Distorted AC Line 230 V / 50 Hz.  
 Ch1: V<sub>IN</sub>; 200 V / div.  
 Ch3: I<sub>IN</sub>; 50 mA / div.  
 Ch4: I<sub>OUT</sub>; 50 mA / div.  
 Time Scale: 5 ms / div.

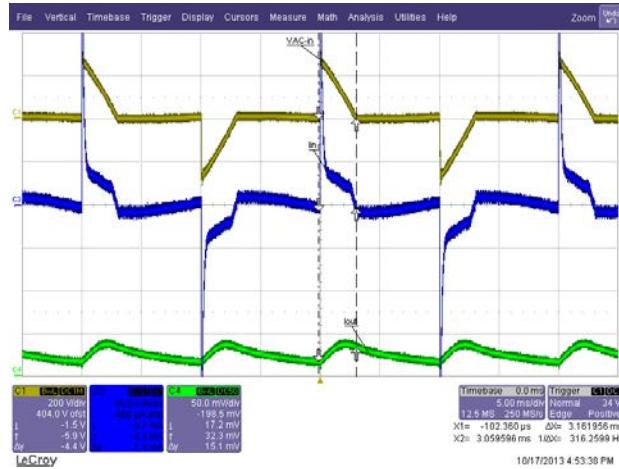




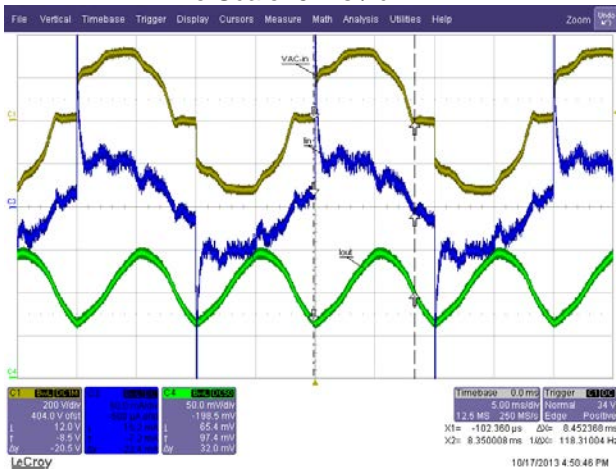
Dimmer: Jung 266 G DE



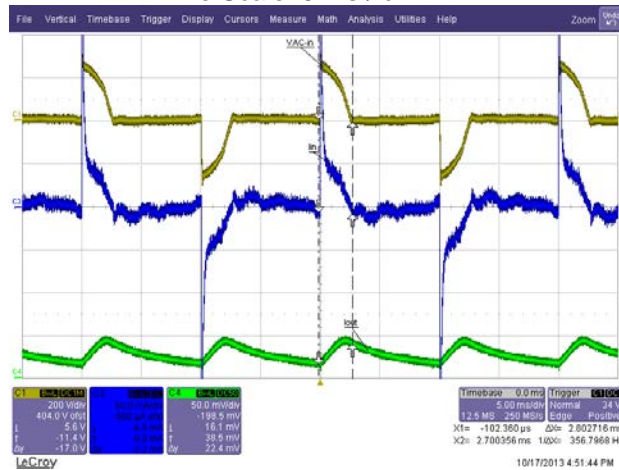
**Figure 61** – Full Conduction from Regulated AC Input 230 V / 50 Hz.  
 Ch1:  $V_{IN}$ ; 200 V / div.  
 Ch3:  $I_{IN}$ ; 50 mA / div.  
 Ch4:  $I_{OUT}$ ; 50 mA / div.  
 Time Scale: 5 ms / div.



**Figure 62** – Minimum Conduction from Regulated AC Input 230 V / 50 Hz.  
 Ch1:  $V_{IN}$ ; 200 V / div.  
 Ch3:  $I_{IN}$ ; 50 mA / div.  
 Ch4:  $I_{OUT}$ ; 50 mA / div.  
 Time Scale: 5 ms / div.



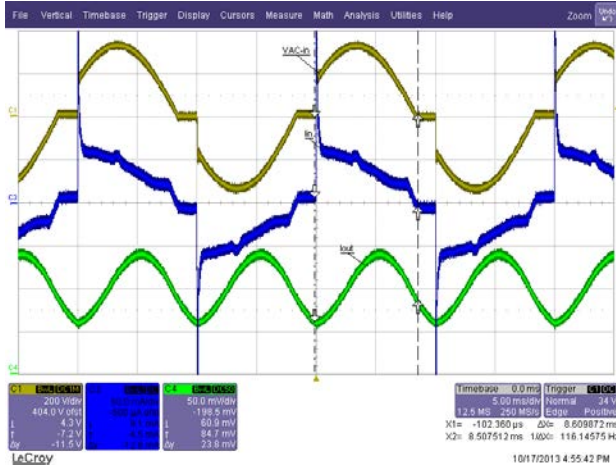
**Figure 63** – Full Conduction from Distorted AC Line 230 V / 50 Hz.  
 Ch1:  $V_{IN}$ ; 200 V / div.  
 Ch3:  $I_{IN}$ ; 50 mA / div.  
 Ch4:  $I_{OUT}$ ; 50 mA / div.  
 Time Scale: 5 ms / div.



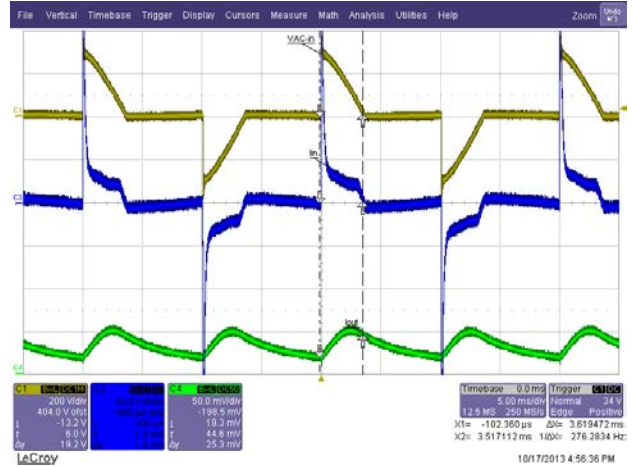
**Figure 64** – Minimum Conduction from Distorted AC Line 230 V / 50 Hz.  
 Ch1:  $V_{IN}$ ; 200 V / div.  
 Ch3:  $I_{IN}$ ; 50 mA / div.  
 Ch4:  $I_{OUT}$ ; 50 mA / div.  
 Time Scale: 5 ms / div.



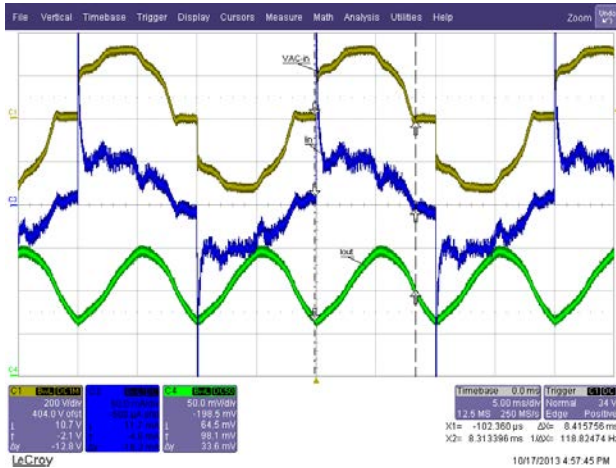
Dimmer: Busch 2200 UJ-212



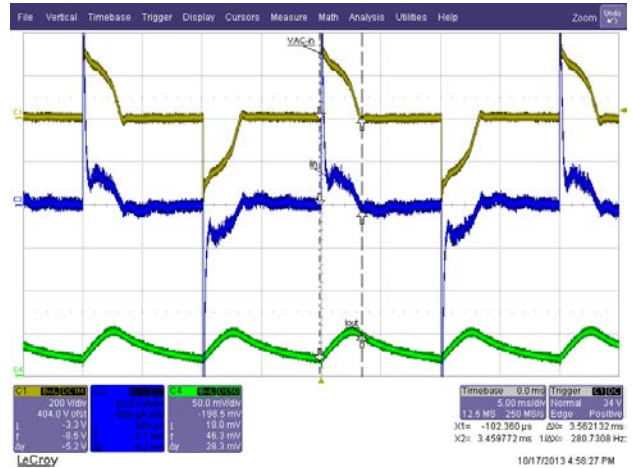
**Figure 65** – Full Conduction from Regulated AC Input 230 V / 50 Hz.  
 Ch1:  $V_{IN}$ ; 200 V / div.  
 Ch3:  $I_{IN}$ ; 50 mA / div.  
 Ch4:  $I_{OUT}$ ; 50 mA / div.  
 Time Scale: 5 ms / div.



**Figure 66** – Minimum Conduction from Regulated AC Input 230 V / 50 Hz.  
 Ch1:  $V_{IN}$ ; 200 V / div.  
 Ch3:  $I_{IN}$ ; 50 mA / div.  
 Ch4:  $I_{OUT}$ ; 50 mA / div.  
 Time Scale: 5 ms / div.



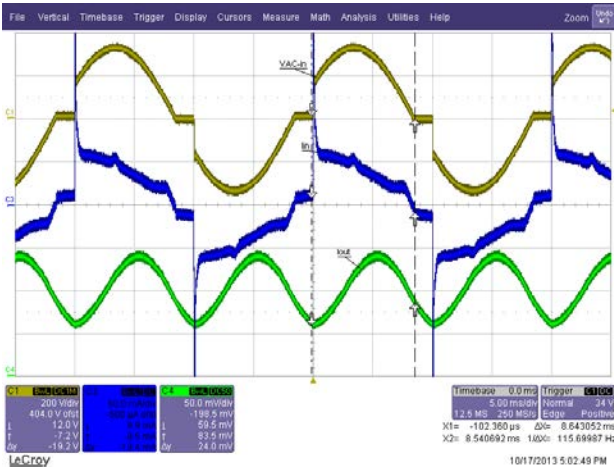
**Figure 67** – Full Conduction from Distorted AC Line 230 V / 50 Hz.  
 Ch1:  $V_{IN}$ ; 200 V / div.  
 Ch3:  $I_{IN}$ ; 50 mA / div.  
 Ch4:  $I_{OUT}$ ; 50 mA / div.  
 Time Scale: 5 ms / div.



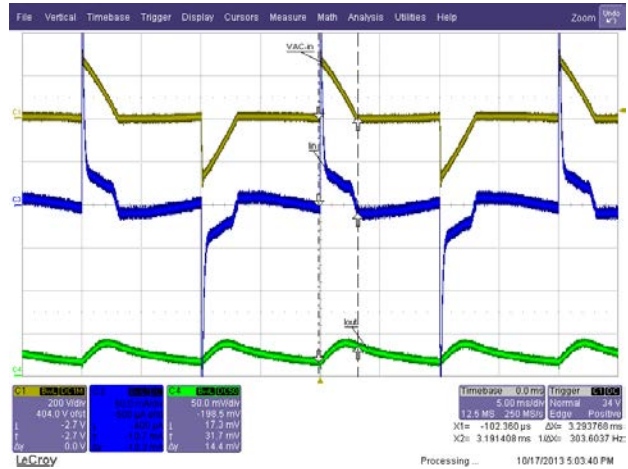
**Figure 68** – Minimum Conduction from Distorted AC Line 230 V / 50 Hz.  
 Ch1:  $V_{IN}$ ; 200 V / div.  
 Ch3:  $I_{IN}$ ; 50 mA / div.  
 Ch4:  $I_{OUT}$ ; 50 mA / div.  
 Time Scale: 5 ms / div.



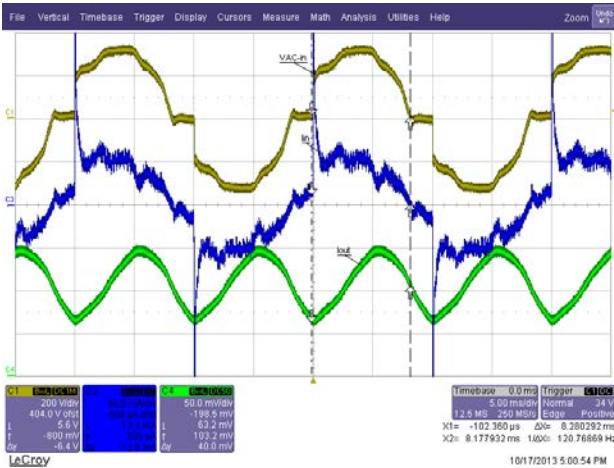
Dimmer: Busch 2250 U



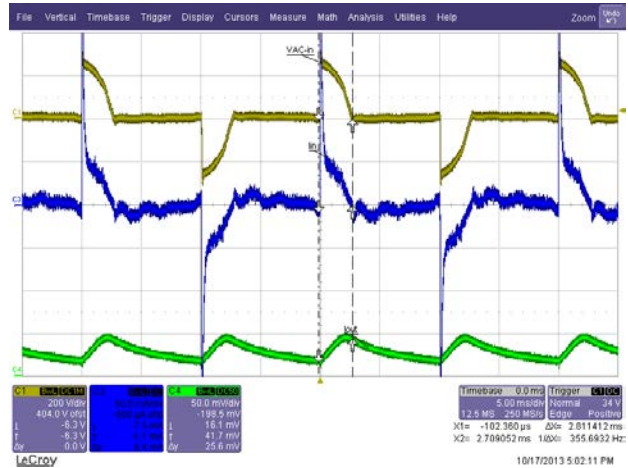
**Figure 69** – Full Conduction from Regulated AC Input 230 V / 50 Hz.  
 Ch1:  $V_{IN}$ ; 200 V / div.  
 Ch3:  $I_{IN}$ ; 50 mA / div.  
 Ch4:  $I_{OUT}$ ; 50 mA / div.  
 Time Scale: 5 ms / div.



**Figure 70** – Minimum Conduction from Regulated AC Input 230 V / 50 Hz.  
 Ch1:  $V_{IN}$ ; 200 V / div.  
 Ch3:  $I_{IN}$ ; 50 mA / div.  
 Ch4:  $I_{OUT}$ ; 50 mA / div.  
 Time Scale: 5 ms / div.



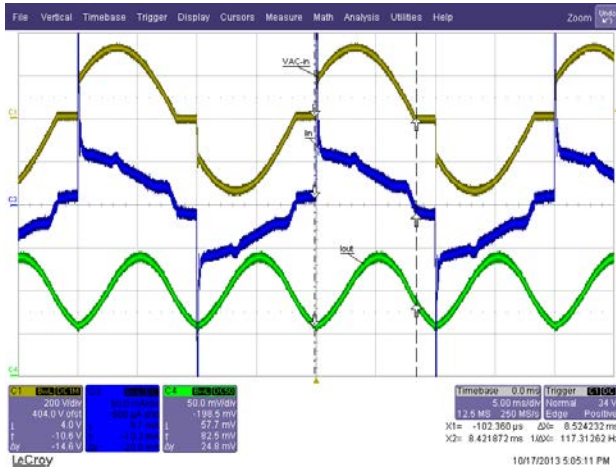
**Figure 71** – Full Conduction from Distorted AC Line 230 V / 50 Hz.  
 Ch1:  $V_{IN}$ ; 200 V / div.  
 Ch3:  $I_{IN}$ ; 50 mA / div.  
 Ch4:  $I_{OUT}$ ; 50 mA / div.  
 Time Scale: 5 ms / div.



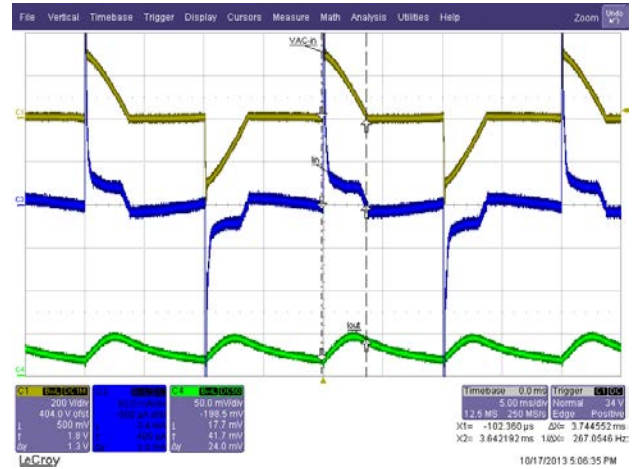
**Figure 72** – Minimum Conduction from Distorted AC Line 230 V / 50 Hz.  
 Ch1:  $V_{IN}$ ; 200 V / div.  
 Ch3:  $I_{IN}$ ; 50 mA / div.  
 Ch4:  $I_{OUT}$ ; 50 mA / div.  
 Time Scale: 5 ms / div.



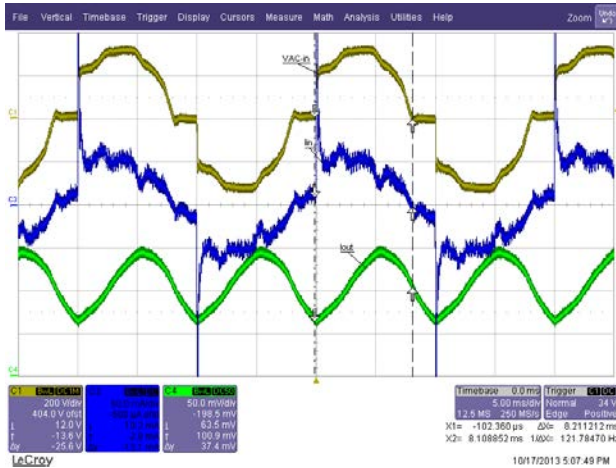
Dimmer: Busch 2247 U



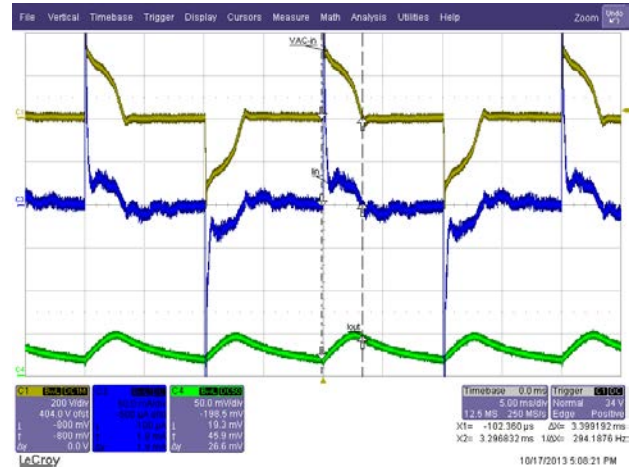
**Figure 73** – Full Conduction from Regulated AC Input 230 V / 50 Hz.  
 Ch1:  $V_{IN}$ ; 200 V / div.  
 Ch3:  $I_{IN}$ ; 50 mA / div.  
 Ch4:  $I_{OUT}$ ; 50 mA / div.  
 Time Scale: 5 ms / div.



**Figure 74** – Minimum Conduction from Regulated AC Input 230 V / 50 Hz.  
 Ch1:  $V_{IN}$ ; 200 V / div.  
 Ch3:  $I_{IN}$ ; 50 mA / div.  
 Ch4:  $I_{OUT}$ ; 50 mA / div.  
 Time Scale: 5 ms / div.



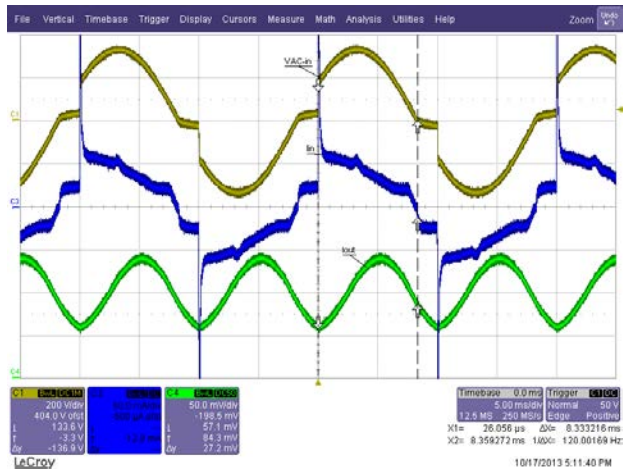
**Figure 75** – Full Conduction from Distorted AC Line 230 V / 50 Hz.  
 Ch1:  $V_{IN}$ ; 200 V / div.  
 Ch3:  $I_{IN}$ ; 50 mA / div.  
 Ch4:  $I_{OUT}$ ; 50 mA / div.  
 Time Scale: 5 ms / div.



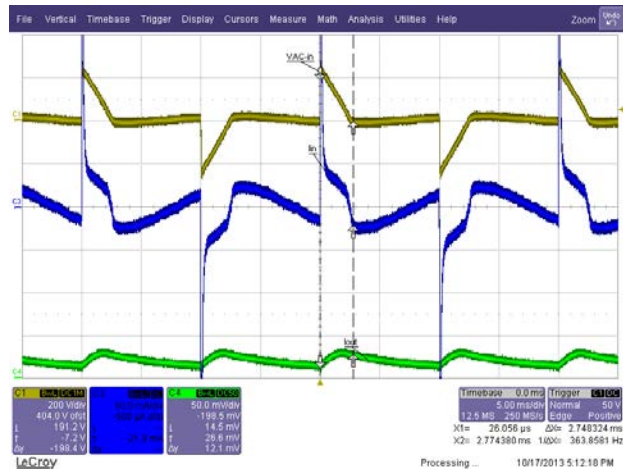
**Figure 76** – Minimum Conduction from Distorted AC Line 230V/50Hz.  
 Ch1:  $V_{IN}$ ; 200 V / div.  
 Ch3:  $I_{IN}$ ; 50 mA / div.  
 Ch4:  $I_{OUT}$ ; 50 mA / div.  
 Time Scale: 5 ms / div.



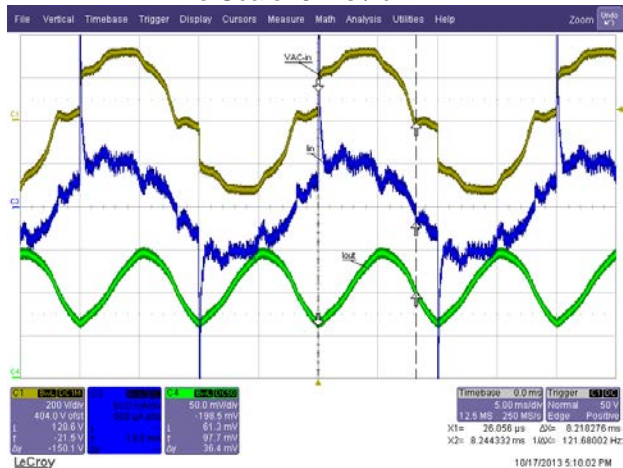
Dimmer: Gira 2262 00 I01



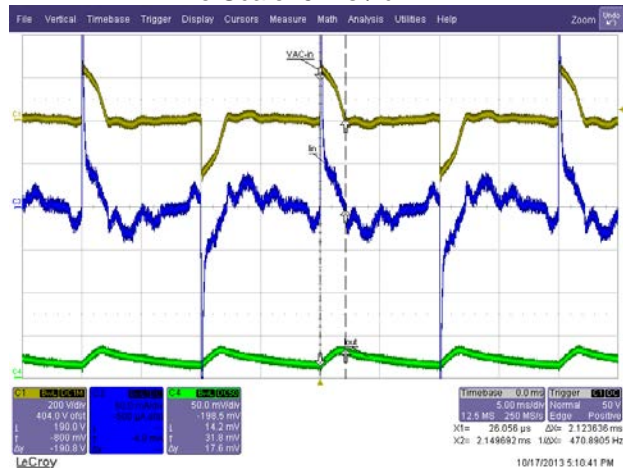
**Figure 77** – Full Conduction from Regulated AC Input 230 V / 50 Hz.  
 Ch1:  $V_{IN}$ ; 200 V / div.  
 Ch3:  $I_{IN}$ ; 50 mA / div.  
 Ch4:  $I_{OUT}$ ; 50 mA / div.  
 Time Scale: 5 ms / div.



**Figure 78** – Minimum Conduction from Regulated AC Input 230 V / 50 Hz.  
 Ch1:  $V_{IN}$ ; 200 V / div.  
 Ch3:  $I_{IN}$ ; 50 mA / div.  
 Ch4:  $I_{OUT}$ ; 50 mA / div.  
 Time Scale: 5 ms / div.



**Figure 79** – Full Conduction from Distorted AC Line 230 V / 50 Hz.  
 Ch1:  $V_{IN}$ ; 200 V / div.  
 Ch3:  $I_{IN}$ ; 50 mA / div.  
 Ch4:  $I_{OUT}$ ; 50 mA / div.  
 Time Scale: 5 ms / div.

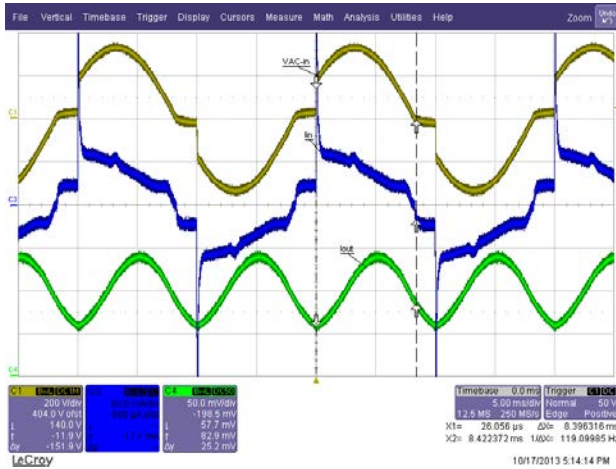


**Figure 80** – Minimum Conduction from Distorted AC Line 230 V / 50 Hz.  
 Ch1:  $V_{IN}$ ; 200 V / div.  
 Ch3:  $I_{IN}$ ; 50 mA / div.  
 Ch4:  $I_{OUT}$ ; 50 mA / div.  
 Time Scale: 5 ms / div.

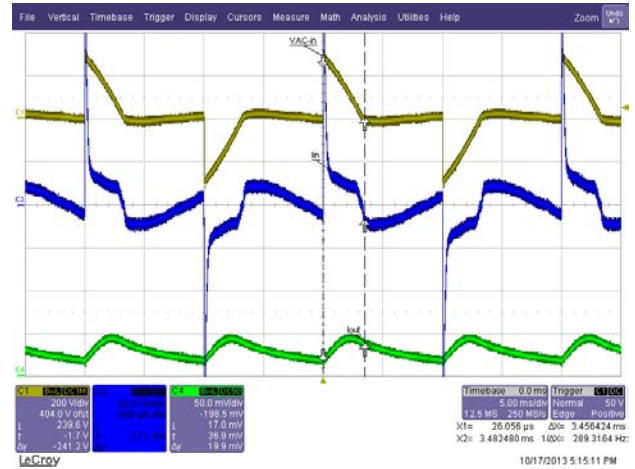




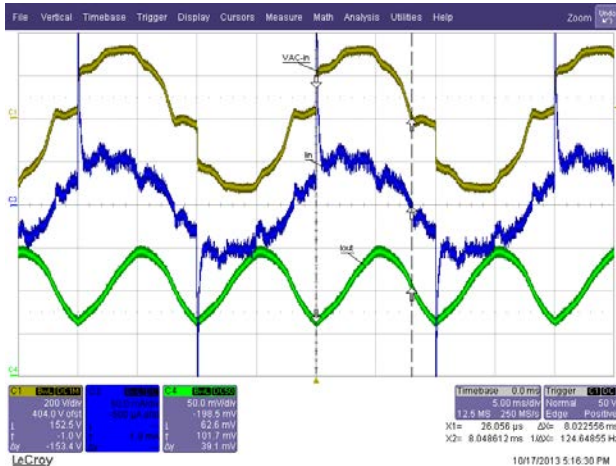
Dimmer: Gira 0300 00 I01



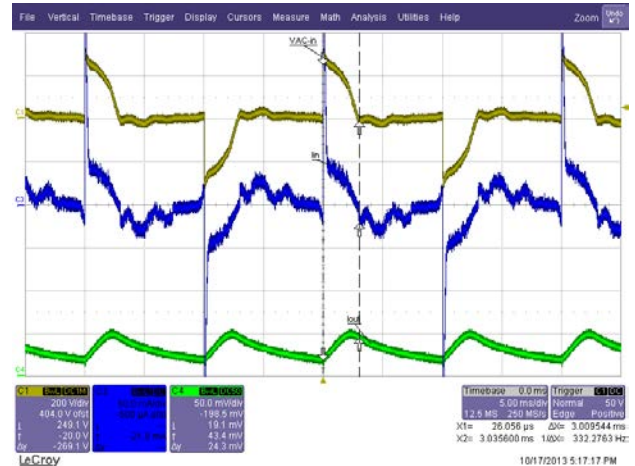
**Figure 81** – Full Conduction from Regulated AC  
 Input 230 V / 50 Hz.  
 Ch1:  $V_{IN}$ ; 200 V / div.  
 Ch3:  $I_{IN}$ ; 50 mA / div.  
 Ch4:  $I_{OUT}$ ; 50 mA / div.  
 Time Scale: 5 ms / div.



**Figure 82** – Minimum Conduction from Regulated AC  
 AC Input 230 V / 50 Hz.  
 Ch1:  $V_{IN}$ ; 200 V / div.  
 Ch3:  $I_{IN}$ ; 50 mA / div.  
 Ch4:  $I_{OUT}$ ; 50 mA / div.  
 Time Scale: 5 ms / div.



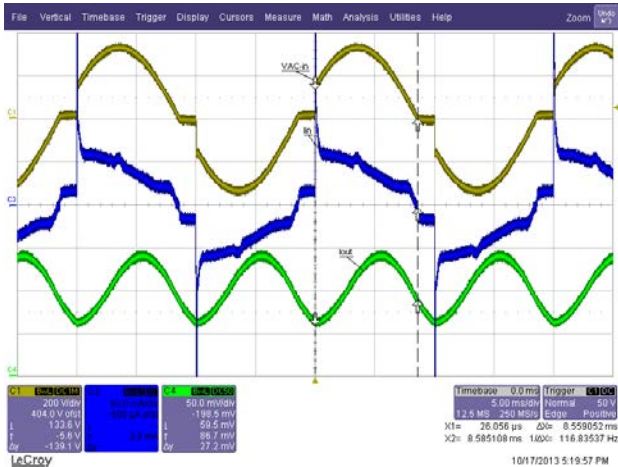
**Figure 83** – Full Conduction from Distorted AC Line  
 230 V / 50 Hz.  
 Ch1:  $V_{IN}$ ; 200 V / div.  
 Ch3:  $I_{IN}$ ; 50 mA / div.  
 Ch4:  $I_{OUT}$ ; 50 mA / div.  
 Time Scale: 5 ms / div.



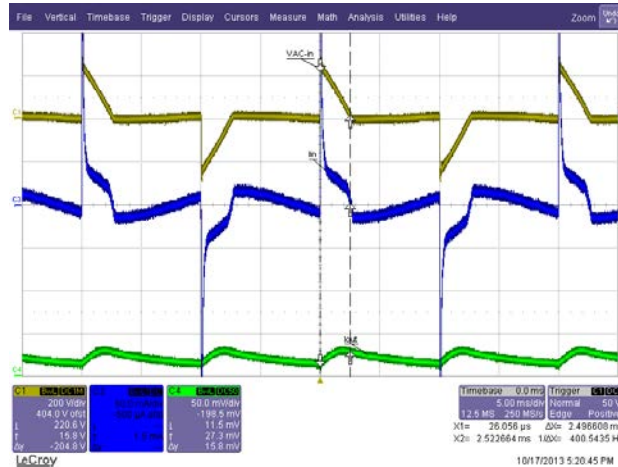
**Figure 84** – Minimum Conduction from Distorted AC Line  
 AC Line 230 V / 50 Hz.  
 Ch1:  $V_{IN}$ ; 200 V / div.  
 Ch3:  $I_{IN}$ ; 50 mA / div.  
 Ch4:  $I_{OUT}$ ; 50 mA / div.  
 Time Scale: 5 ms / div.



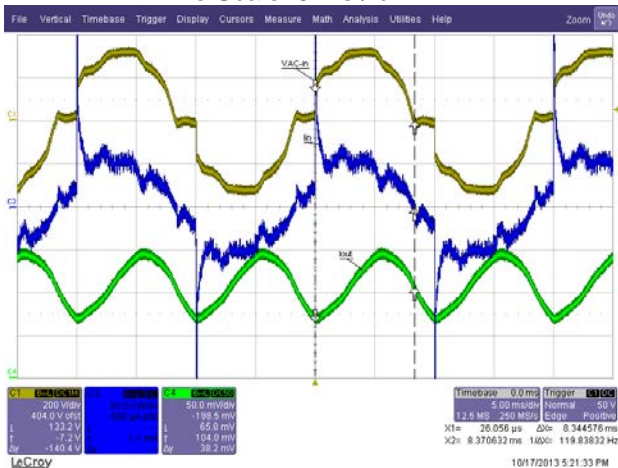
Dimmer: Busch 2250 U



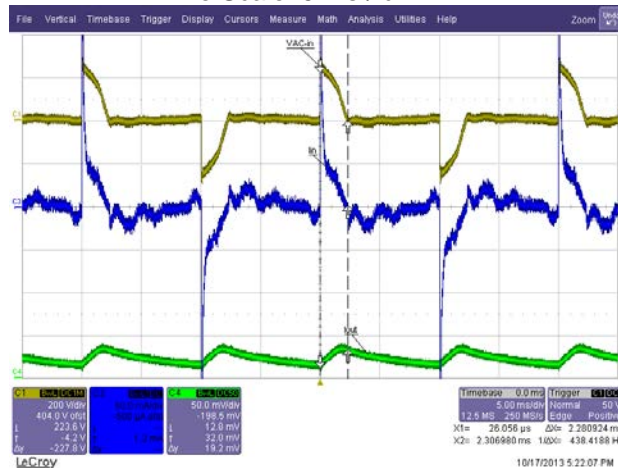
**Figure 85** – Full Conduction from Regulated AC Input 230 V / 50 Hz.  
 Ch1:  $V_{IN}$ ; 200 V / div.  
 Ch3:  $I_{IN}$ ; 50 mA / div.  
 Ch4:  $I_{OUT}$ ; 50 mA / div.  
 Time Scale: 5 ms / div.



**Figure 86** – Minimum Conduction from Regulated AC Input 230 V / 50 Hz.  
 Ch1:  $V_{IN}$ ; 200 V / div.  
 Ch3:  $I_{IN}$ ; 50 mA / div.  
 Ch4:  $I_{OUT}$ ; 50 mA / div.  
 Time Scale: 5 ms / div.



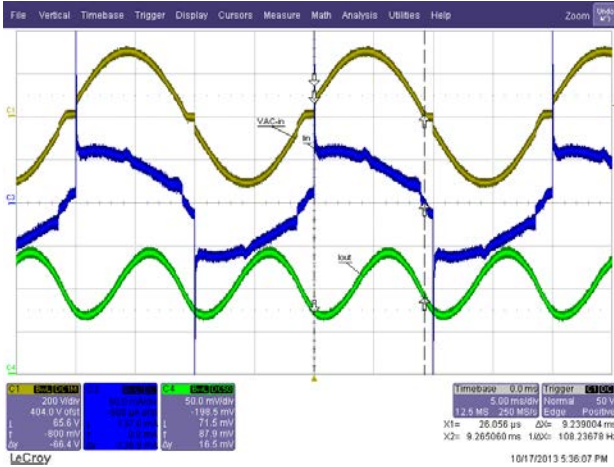
**Figure 87** – Full Conduction from Distorted AC Line 230 V / 50 Hz.  
 Ch1:  $V_{IN}$ ; 200 V / div.  
 Ch3:  $I_{IN}$ ; 50 mA / div.  
 Ch4:  $I_{OUT}$ ; 50 mA / div.  
 Time Scale: 5 ms / div.



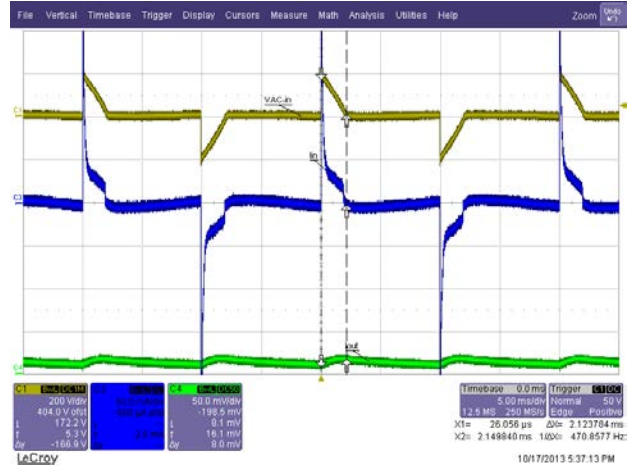
**Figure 88** – Minimum Conduction from Distorted AC Line 230 V / 50 Hz.  
 Ch1:  $V_{IN}$ ; 200 V / div.  
 Ch3:  $I_{IN}$ ; 50 mA / div.  
 Ch4:  $I_{OUT}$ ; 50 mA / div.  
 Time Scale: 5 ms / div.



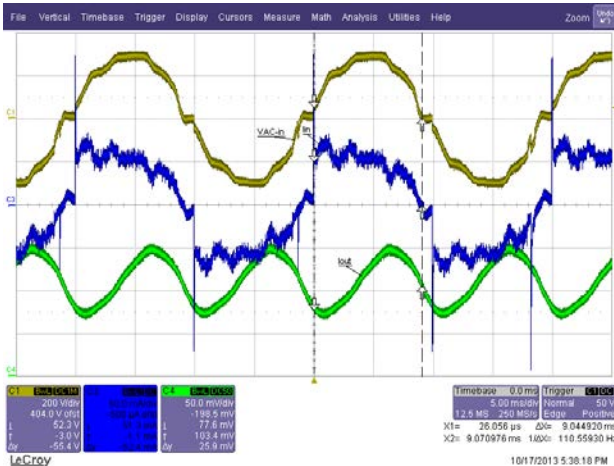
Dimmer: TCL



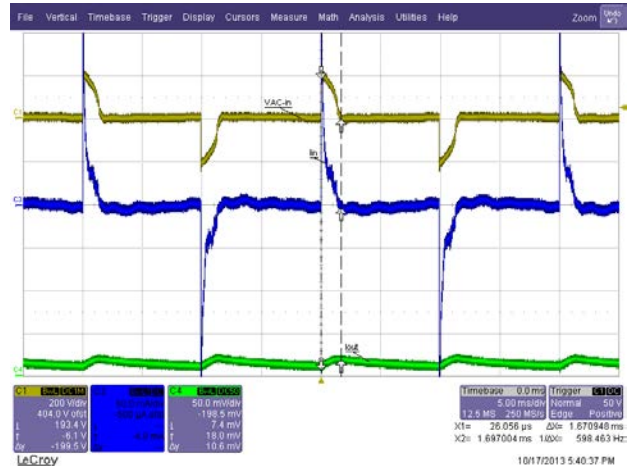
**Figure 89** – Full Conduction from Regulated AC Input 230 V / 50 Hz.  
 Ch1:  $V_{IN}$ ; 200 V / div.  
 Ch3:  $I_{IN}$ ; 50 mA / div.  
 Ch4:  $I_{OUT}$ ; 50 mA / div.  
 Time Scale: 5 ms / div.



**Figure 90** – Minimum Conduction from Regulated AC Input 230 V / 50 Hz.  
 Ch1:  $V_{IN}$ ; 200 V / div.  
 Ch3:  $I_{IN}$ ; 50 mA / div.  
 Ch4:  $I_{OUT}$ ; 50 mA / div.  
 Time Scale: 5 ms / div.



**Figure 91** – Full Conduction from Distorted AC Line 230 V / 50 Hz.  
 Ch1:  $V_{IN}$ ; 200 V / div.  
 Ch3:  $I_{IN}$ ; 50 mA / div.  
 Ch4:  $I_{OUT}$ ; 50 mA / div.  
 Time Scale: 5 ms / div.

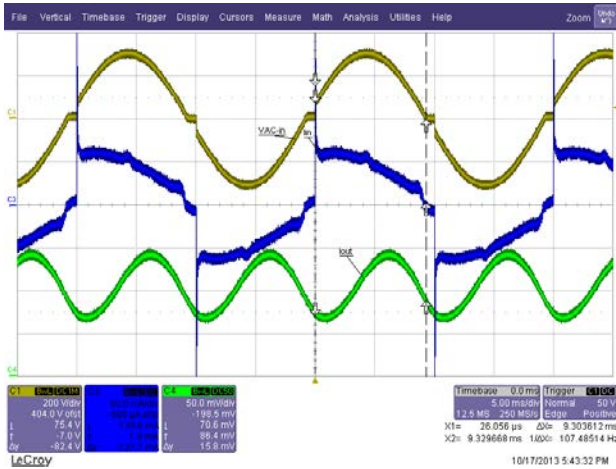


**Figure 92** – Minimum Conduction from Distorted AC Line 230 V / 50 Hz.  
 Ch1:  $V_{IN}$ ; 200 V / div.  
 Ch3:  $I_{IN}$ ; 50 mA / div.  
 Ch4:  $I_{OUT}$ ; 50 mA / div.  
 Time Scale: 5 ms / div.

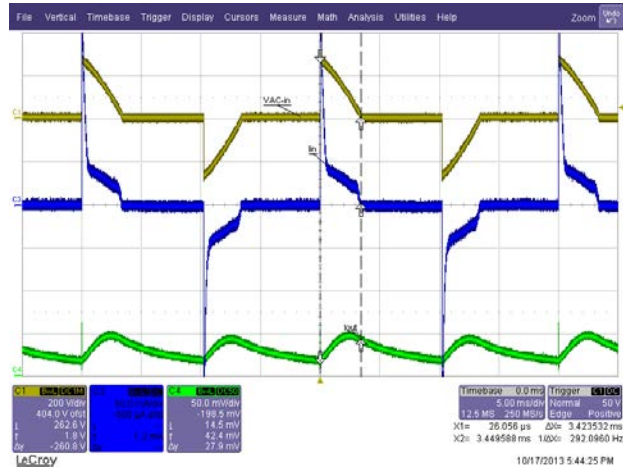




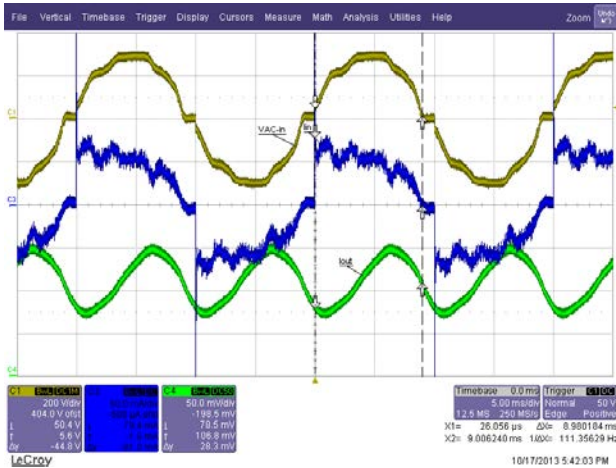
Dimmer: SEN BO LANG



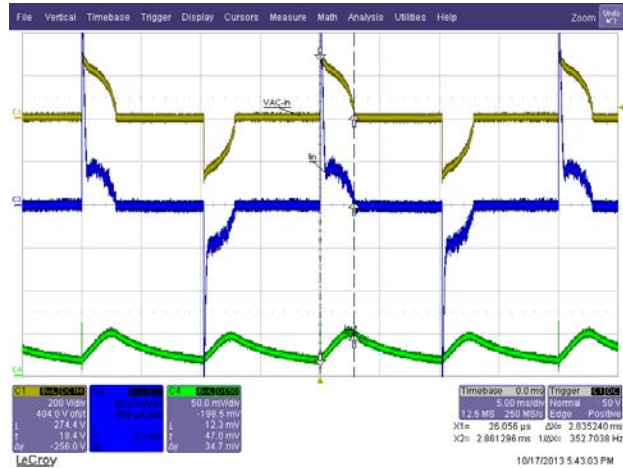
**Figure 93** – Full Conduction from Regulated AC Input 230 V / 50 Hz.  
 Ch1:  $V_{IN}$ ; 200 V / div.  
 Ch3:  $I_{IN}$ ; 50 mA / div.  
 Ch4:  $I_{OUT}$ ; 50 mA / div.  
 Time Scale: 5 ms / div.



**Figure 94** – Minimum Conduction from Regulated AC Input 230 V / 50 Hz.  
 Ch1:  $V_{IN}$ ; 200 V / div.  
 Ch3:  $I_{IN}$ ; 50 mA / div.  
 Ch4:  $I_{OUT}$ ; 50 mA / div.  
 Time Scale: 5 ms / div.



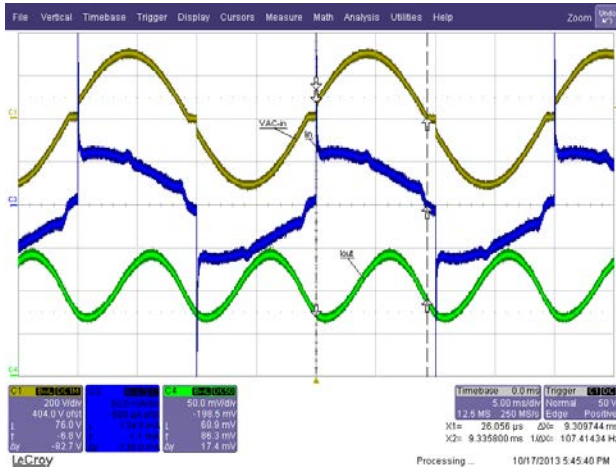
**Figure 95** – Full Conduction from Distorted AC Line 230 V / 50 Hz.  
 Ch1:  $V_{IN}$ ; 200 V / div.  
 Ch3:  $I_{IN}$ ; 50 mA / div.  
 Ch4:  $I_{OUT}$ ; 50 mA / div.  
 Time Scale: 5 ms / div.



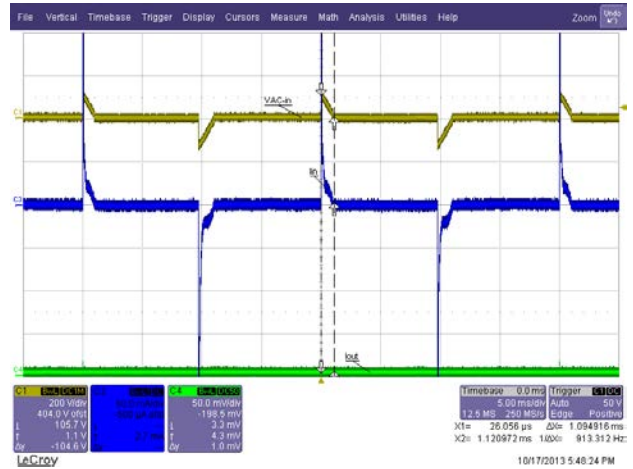
**Figure 96** – Minimum Conduction from Distorted AC Line 230 V / 50 Hz.  
 Ch1:  $V_{IN}$ ; 200 V / div.  
 Ch3:  $I_{IN}$ ; 50 mA / div.  
 Ch4:  $I_{OUT}$ ; 50 mA / div.  
 Time Scale: 5 ms / div.



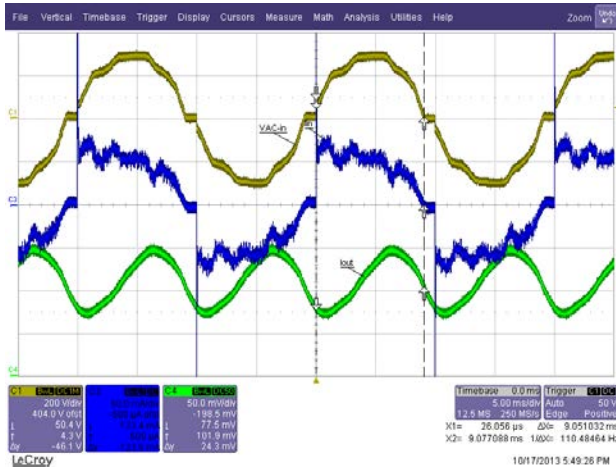
Dimmer: EBA HUANG



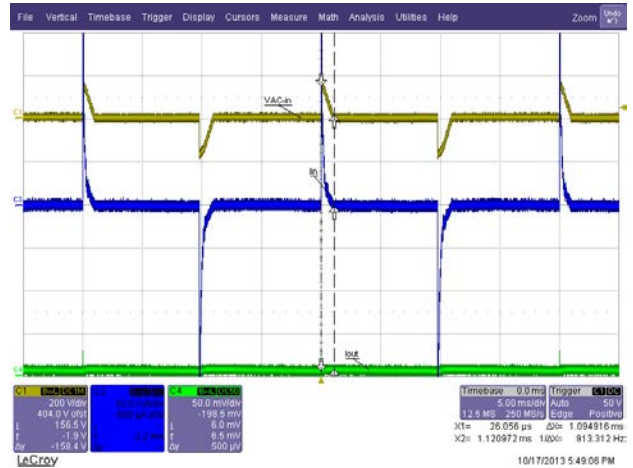
**Figure 97** – Full Conduction from Regulated AC Input 230 V / 50 Hz.  
 Ch1:  $V_{IN}$ ; 200 V / div.  
 Ch3:  $I_{IN}$ ; 50 mA / div.  
 Ch4:  $I_{OUT}$ ; 50 mA / div.  
 Time Scale: 5 ms / div.



**Figure 98** – Minimum Conduction from Regulated AC Input 230 V / 50 Hz.  
 Ch1:  $V_{IN}$ ; 200 V / div.  
 Ch3:  $I_{IN}$ ; 50 mA / div.  
 Ch4:  $I_{OUT}$ ; 50 mA / div.  
 Time Scale: 5 ms / div.



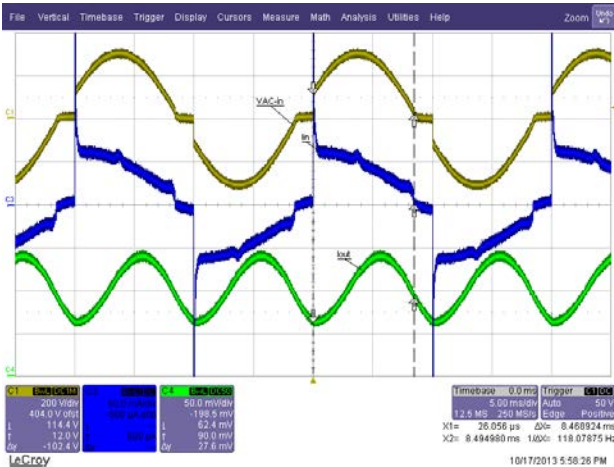
**Figure 99** – Full Conduction from Distorted AC Line 230 V / 50 Hz.  
 Ch1:  $V_{IN}$ ; 200 V / div.  
 Ch3:  $I_{IN}$ ; 50 mA / div.  
 Ch4:  $I_{OUT}$ ; 50 mA / div.  
 Time Scale: 5 ms / div.



**Figure 100** – Minimum Conduction from Distorted AC Line 230 V / 50 Hz.  
 Ch1:  $V_{IN}$ ; 200 V / div.  
 Ch3:  $I_{IN}$ ; 50 mA / div.  
 Ch4:  $I_{OUT}$ ; 50 mA / div.  
 Time Scale: 5 ms / div.



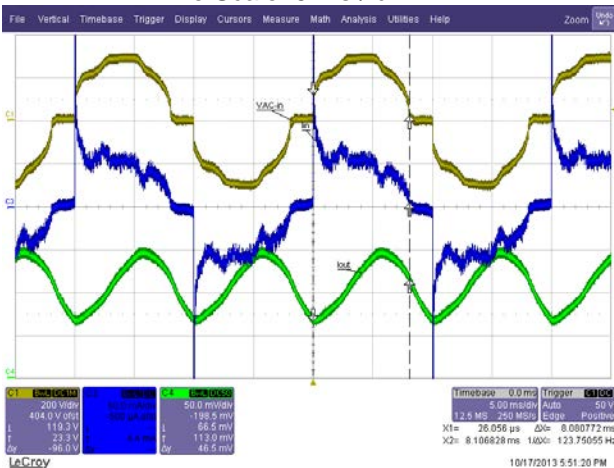
Dimmer: SB ELECT



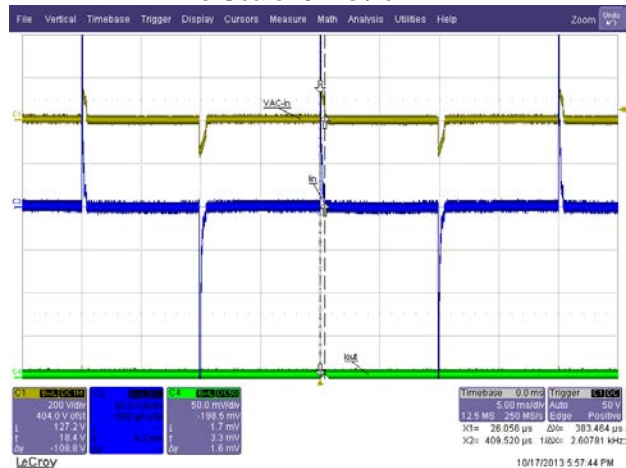
**Figure 101** – Full Conduction from Regulated AC Input 230 V / 50 Hz.  
 Ch1:  $V_{IN}$ ; 200 V / div.  
 Ch3:  $I_{IN}$ ; 50 mA / div.  
 Ch4:  $I_{OUT}$ ; 50 mA / div.  
 Time Scale: 5 ms / div.



**Figure 102** – Minimum Conduction from Regulated AC Input 230 V / 50 Hz.  
 Ch1:  $V_{IN}$ ; 200 V / div.  
 Ch3:  $I_{IN}$ ; 50 mA / div.  
 Ch4:  $I_{OUT}$ ; 50 mA / div.  
 Time Scale: 5 ms / div.



**Figure 103** – Full Conduction from Distorted AC Line 230 V / 50 Hz.  
 Ch1:  $V_{IN}$ ; 200 V / div.  
 Ch3:  $I_{IN}$ ; 50 mA / div.  
 Ch4:  $I_{OUT}$ ; 50 mA / div.  
 Time Scale: 5 ms / div.

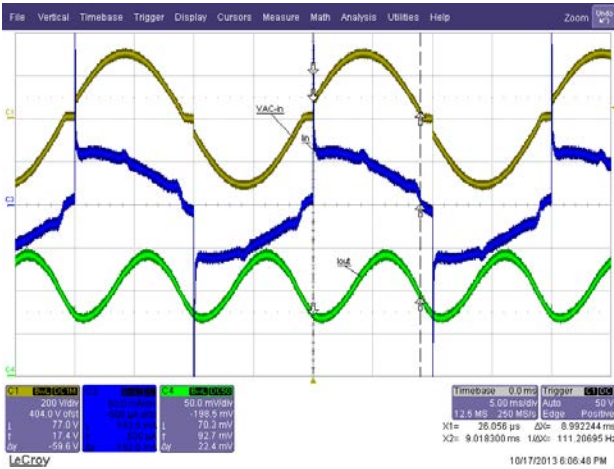


**Figure 104** – Minimum Conduction from Distorted AC Line 230 V / 50 Hz.  
 Ch1:  $V_{IN}$ ; 200 V / div.  
 Ch3:  $I_{IN}$ ; 50 mA / div.  
 Ch4:  $I_{OUT}$ ; 50 mA / div.  
 Time Scale: 5 ms / div.

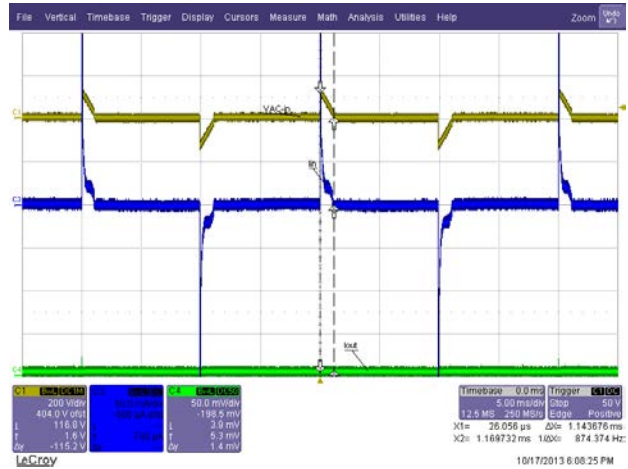




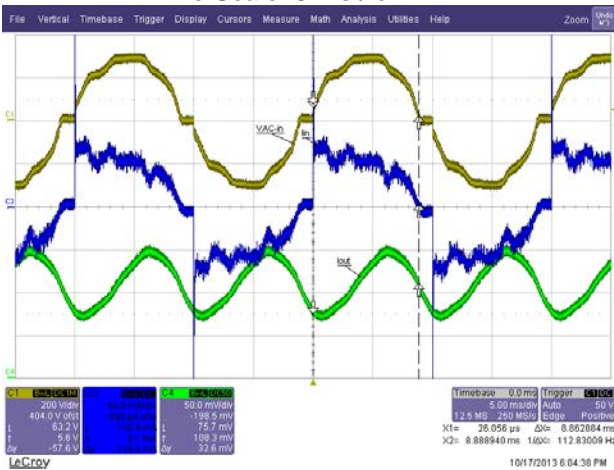
Dimmer: KBE



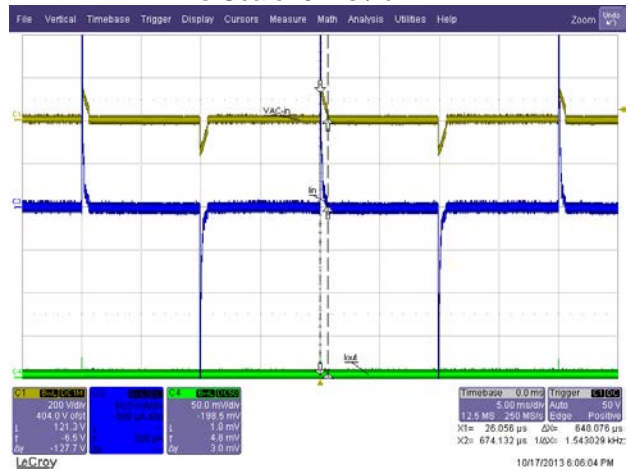
**Figure 109** – Full Conduction from Regulated AC Input 230 V / 50 Hz.  
 Ch1:  $V_{IN}$ ; 200 V / div.  
 Ch3:  $I_{IN}$ ; 50 mA / div.  
 Ch4:  $I_{OUT}$ ; 50 mA / div.  
 Time Scale: 5 ms / div.



**Figure 110** – Minimum Conduction from Regulated AC Input 230 V / 50 Hz.  
 Ch1:  $V_{IN}$ ; 200 V / div.  
 Ch3:  $I_{IN}$ ; 50 mA / div.  
 Ch4:  $I_{OUT}$ ; 50 mA / div.  
 Time Scale: 5 ms / div.



**Figure 111** – Full Conduction from Distorted AC Line 230 V / 50 Hz.  
 Ch1:  $V_{IN}$ ; 200 V / div.  
 Ch3:  $I_{IN}$ ; 50 mA / div.  
 Ch4:  $I_{OUT}$ ; 50 mA / div.  
 Time Scale: 5 ms / div.

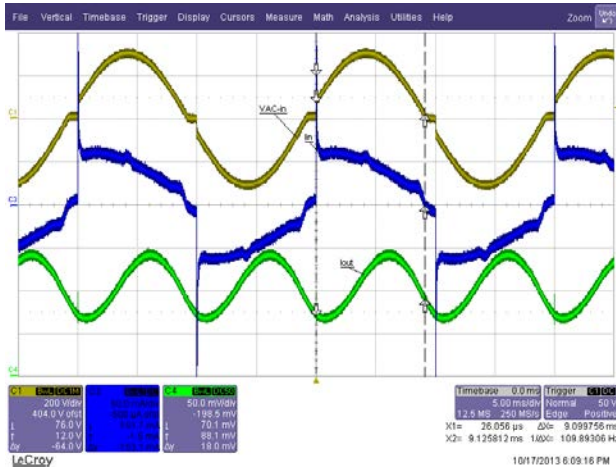


**Figure 112** – Minimum Conduction from Distorted AC Line 230 V / 50 Hz.  
 Ch1:  $V_{IN}$ ; 200 V / div.  
 Ch3:  $I_{IN}$ ; 50 mA / div.  
 Ch4:  $I_{OUT}$ ; 50 mA / div.  
 Time Scale: 5 ms / div.

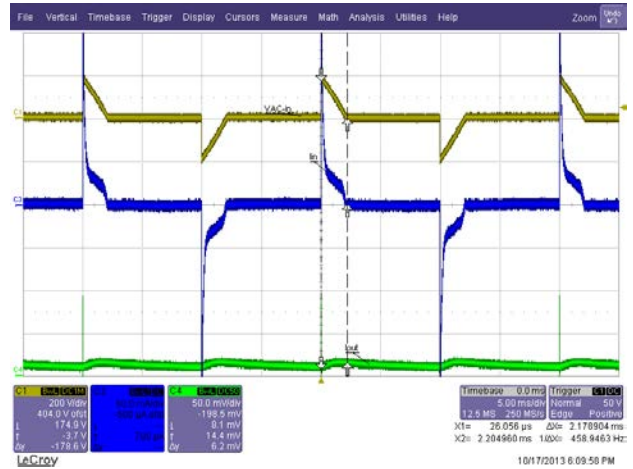




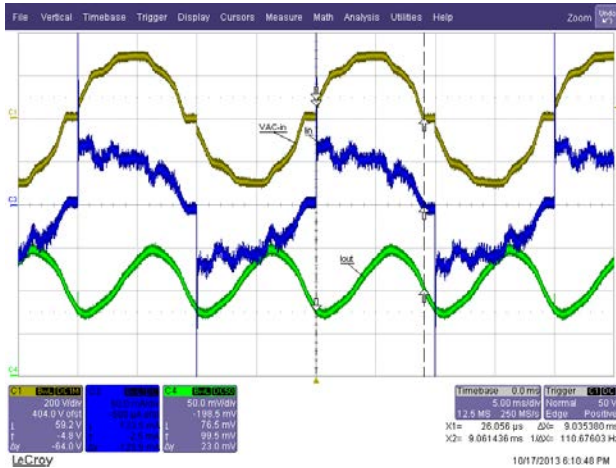
Dimmer: CLIPMEI



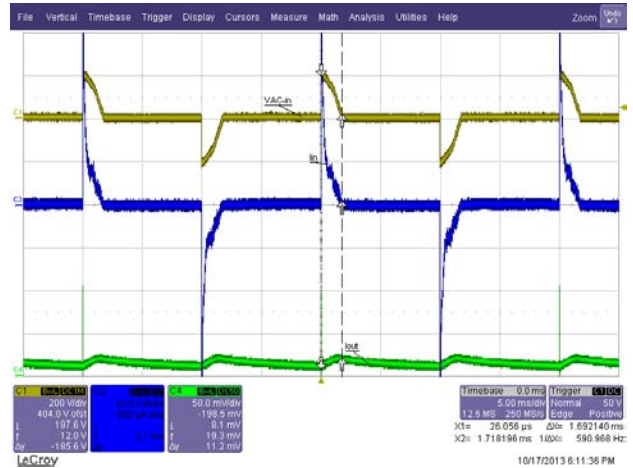
**Figure 113** – Full Conduction from Regulated AC Input 230 V / 50 Hz.  
 Ch1:  $V_{IN}$ ; 200 V / div.  
 Ch3:  $I_{IN}$ ; 50 mA / div.  
 Ch4:  $I_{OUT}$ ; 50 mA / div.  
 Time Scale: 5 ms / div.



**Figure 114** – Minimum Conduction from Regulated AC Input 230 V / 50 Hz.  
 Ch1:  $V_{IN}$ ; 200 V / div.  
 Ch3:  $I_{IN}$ ; 50 mA / div.  
 Ch4:  $I_{OUT}$ ; 50 mA / div.  
 Time Scale: 5 ms / div.



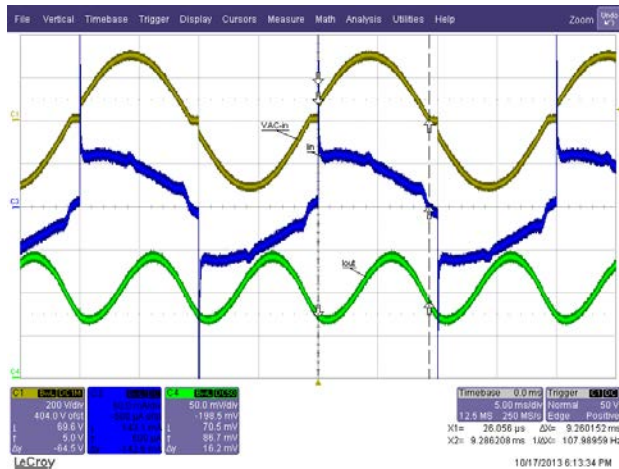
**Figure 115** – Full Conduction from Distorted AC Line 230 V / 50 Hz.  
 Ch1:  $V_{IN}$ ; 200 V / div.  
 Ch3:  $I_{IN}$ ; 50 mA / div.  
 Ch4:  $I_{OUT}$ ; 50 mA / div.  
 Time Scale: 5 ms / div.



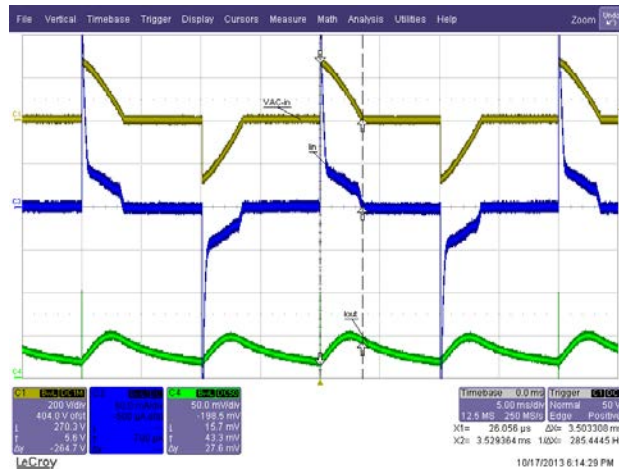
**Figure 116** – Minimum Conduction from Distorted AC Line 230 V / 50 Hz.  
 Ch1:  $V_{IN}$ ; 200 V / div.  
 Ch3:  $I_{IN}$ ; 50 mA / div.  
 Ch4:  $I_{OUT}$ ; 50 mA / div.  
 Time Scale: 5 ms /



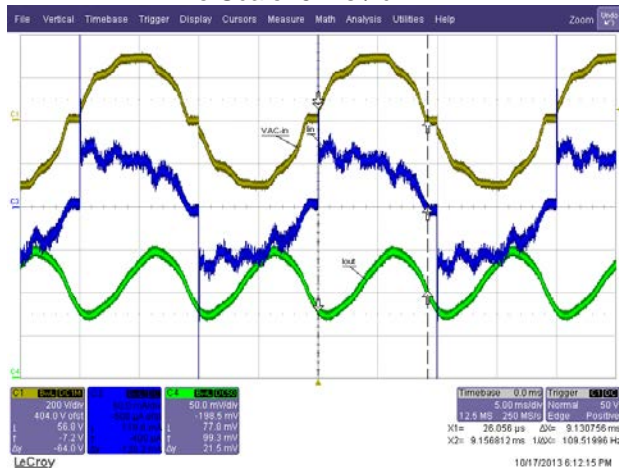
Dimmer: MANK



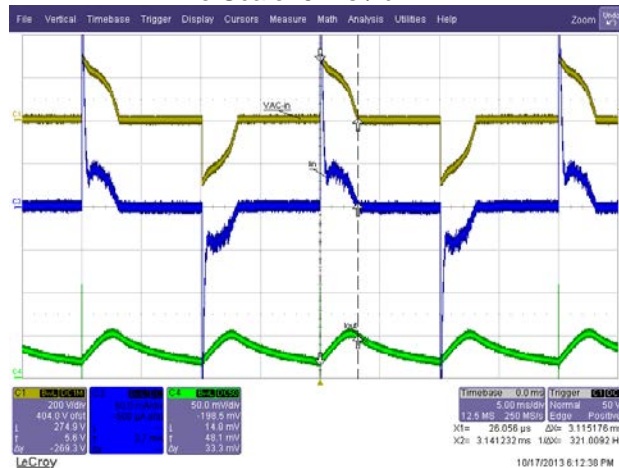
**Figure 117** – Full Conduction from Regulated AC Input 230 V / 50 Hz.  
 Ch1:  $V_{IN}$ ; 200 V / div.  
 Ch3:  $I_{IN}$ ; 50 mA / div.  
 Ch4:  $I_{OUT}$ ; 50 mA / div.  
 Time Scale: 5 ms / div.



**Figure 118** – Minimum Conduction from Regulated AC Input 230 V / 50 Hz.  
 Ch1:  $V_{IN}$ ; 200 V / div.  
 Ch3:  $I_{IN}$ ; 50 mA / div.  
 Ch4:  $I_{OUT}$ ; 50 mA / div.  
 Time Scale: 5 ms / div.



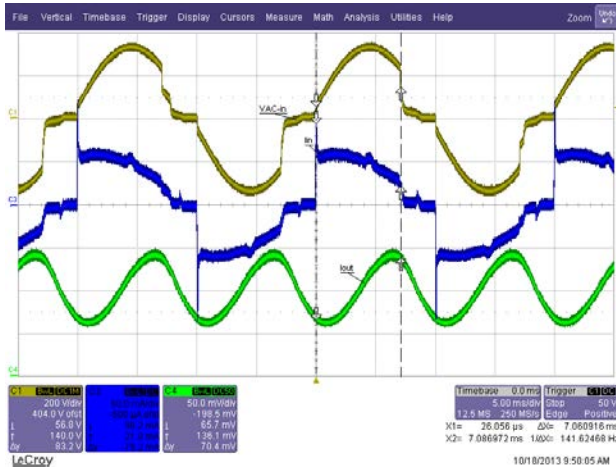
**Figure 119** – Full Conduction from Distorted AC Line 230 V / 50 Hz.  
 Ch1:  $V_{IN}$ ; 200 V / div.  
 Ch3:  $I_{IN}$ ; 50 mA / div.  
 Ch4:  $I_{OUT}$ ; 50 mA / div.  
 Time Scale: 5 ms / div.



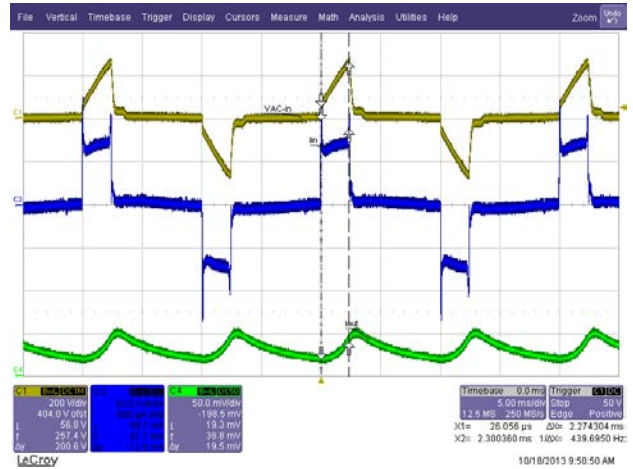
**Figure 120** – Minimum Conduction from Distorted AC Line 230 V / 50 Hz.  
 Ch1:  $V_{IN}$ ; 200 V / div.  
 Ch3:  $I_{IN}$ ; 50 mA / div.  
 Ch4:  $I_{OUT}$ ; 50 mA / div.  
 Time Scale: 5 ms / div.



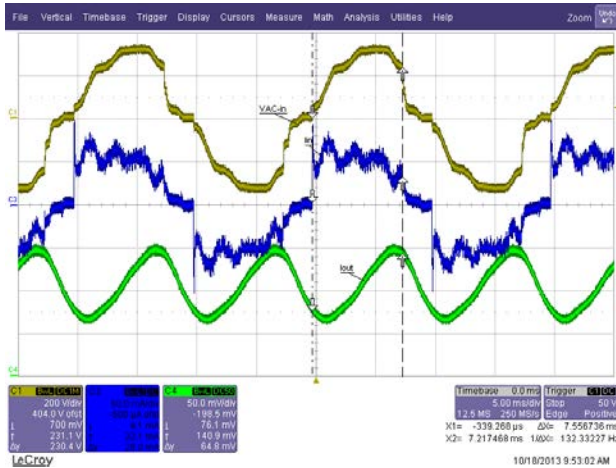
Dimmer: GIRA 1176 00 I03



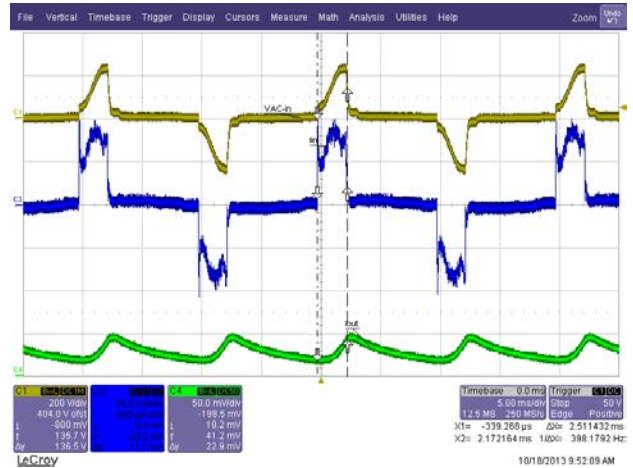
**Figure 121** – Full Conduction from Regulated AC Input 230 V / 50 Hz.  
 Ch1: V<sub>IN</sub>; 200 V / div.  
 Ch3: I<sub>IN</sub>; 50 mA / div.  
 Ch4: I<sub>OUT</sub>; 50 mA / div.  
 Time Scale: 5 ms / div.



**Figure 122** – Minimum Conduction from Regulated AC Input 230 V / 50 Hz.  
 Ch1: V<sub>IN</sub>; 200 V / div.  
 Ch3: I<sub>IN</sub>; 50 mA / div.  
 Ch4: I<sub>OUT</sub>; 50 mA / div.  
 Time Scale: 5 ms / div.



**Figure 123** – Full Conduction from Distorted AC Line 230 V / 50 Hz.  
 Ch1: V<sub>IN</sub>; 200 V / div.  
 Ch3: I<sub>IN</sub>; 50 mA / div.  
 Ch4: I<sub>OUT</sub>; 50 mA / div.  
 Time Scale: 5 ms / div.

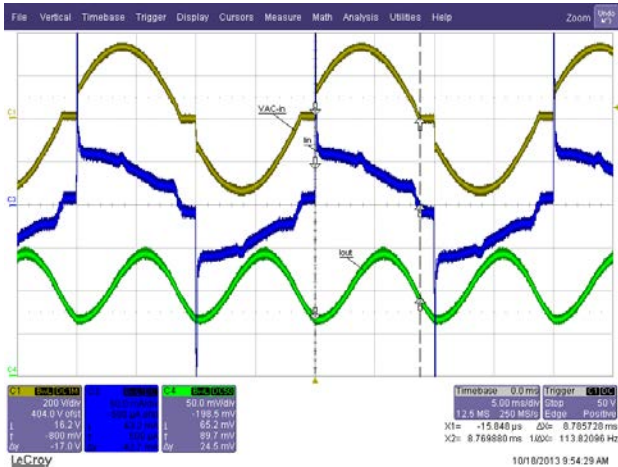


**Figure 124** – Minimum Conduction from Distorted AC Line 230 V / 50 Hz.  
 Ch1: V<sub>IN</sub>; 200 V / div.  
 Ch3: I<sub>IN</sub>; 50 mA / div.  
 Ch4: I<sub>OUT</sub>; 50 mA / div.  
 Time Scale: 5 ms / div.

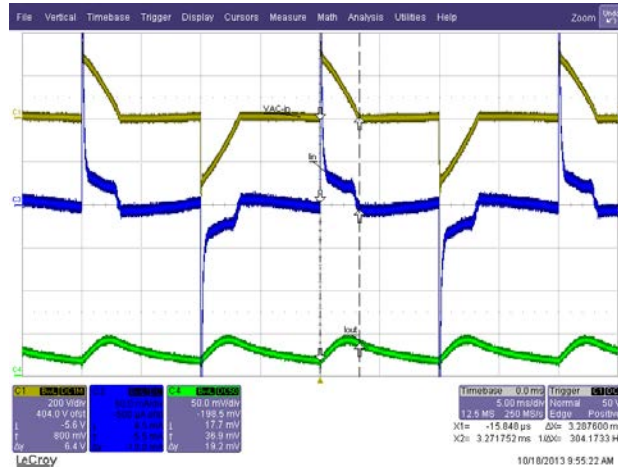




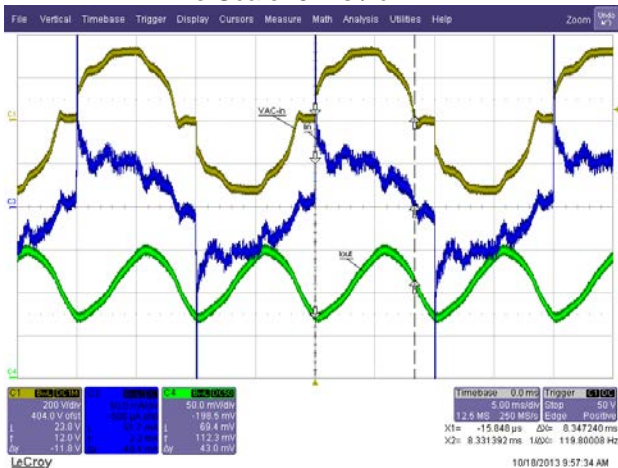
Dimmer: Niko 310-013



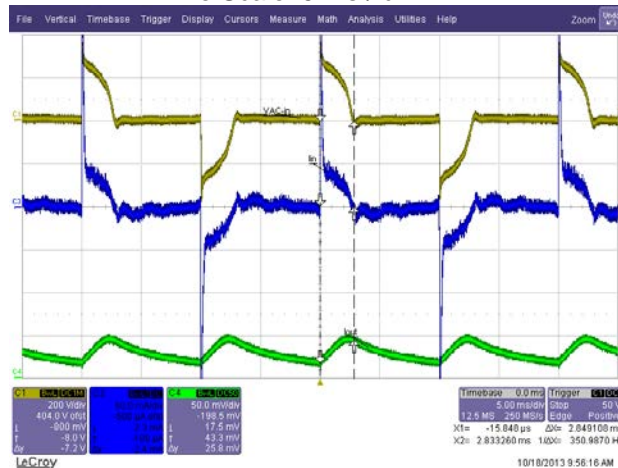
**Figure 125** – Full Conduction from Regulated AC Input 230 V / 50 Hz.  
 Ch1:  $V_{IN}$ ; 200 V / div.  
 Ch3:  $I_{IN}$ ; 50 mA / div.  
 Ch4:  $I_{OUT}$ ; 50 mA / div.  
 Time Scale: 5 ms / div.



**Figure 126** – Minimum Conduction from Regulated AC Input 230 V / 50 Hz.  
 Ch1:  $V_{IN}$ ; 200 V / div.  
 Ch3:  $I_{IN}$ ; 50 mA / div.  
 Ch4:  $I_{OUT}$ ; 50 mA / div.  
 Time Scale: 5 ms / div.



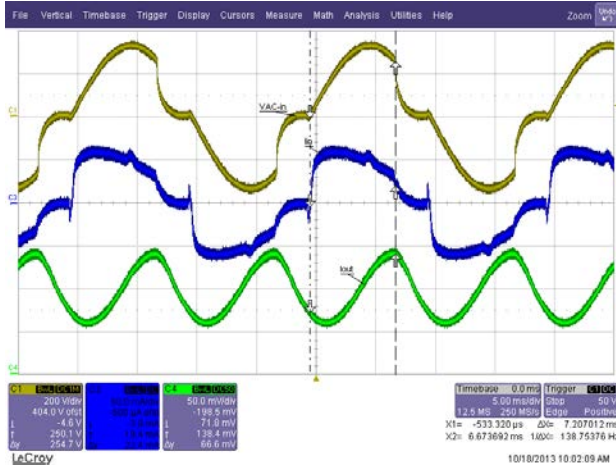
**Figure 127** – Full Conduction from Distorted AC Line 230 V / 50 Hz.  
 Ch1:  $V_{IN}$ ; 200 V / div.  
 Ch3:  $I_{IN}$ ; 50 mA / div.  
 Ch4:  $I_{OUT}$ ; 50 mA / div.  
 Time Scale: 5 ms / div.



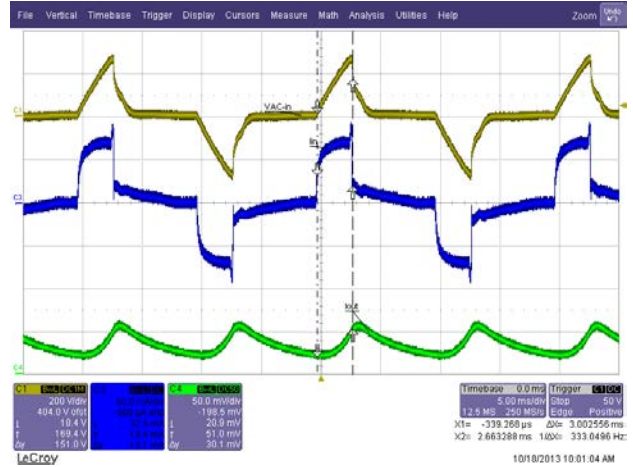
**Figure 128** – Minimum Conduction from Distorted AC Line 230 V / 50 Hz.  
 Ch1:  $V_{IN}$ ; 200 V / div.  
 Ch3:  $I_{IN}$ ; 50 mA / div.  
 Ch4:  $I_{OUT}$ ; 50 mA / div.  
 Time Scale: 5 ms / div.



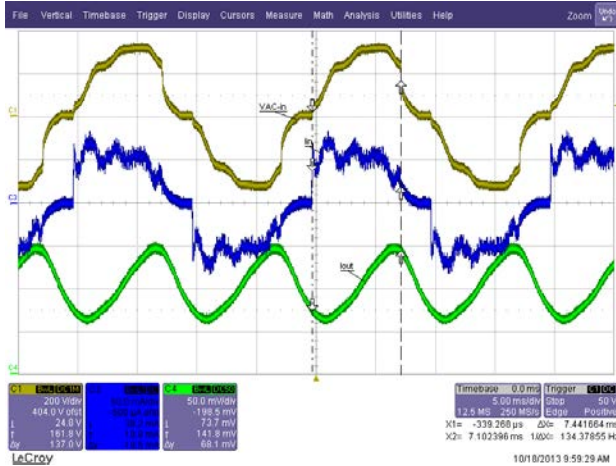
Dimmer: Niko 310-017



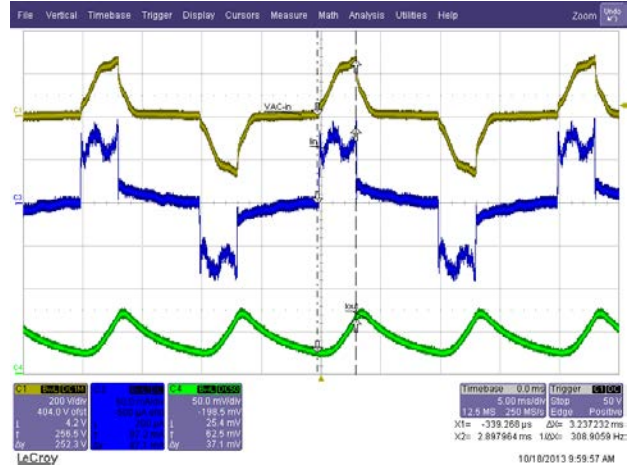
**Figure 129** – Full Conduction from Regulated AC Input 230 V / 50 Hz.  
 Ch1: V<sub>IN</sub>; 200 V / div.  
 Ch3: I<sub>IN</sub>; 50 mA / div.  
 Ch4: I<sub>OUT</sub>; 50 mA / div.  
 Time Scale: 5 ms / div.



**Figure 130** – Minimum Conduction from Regulated AC Input 230 V / 50 Hz.  
 Ch1: V<sub>IN</sub>; 200 V / div.  
 Ch3: I<sub>IN</sub>; 50 mA / div.  
 Ch4: I<sub>OUT</sub>; 50 mA / div.  
 Time Scale: 5 ms / div.



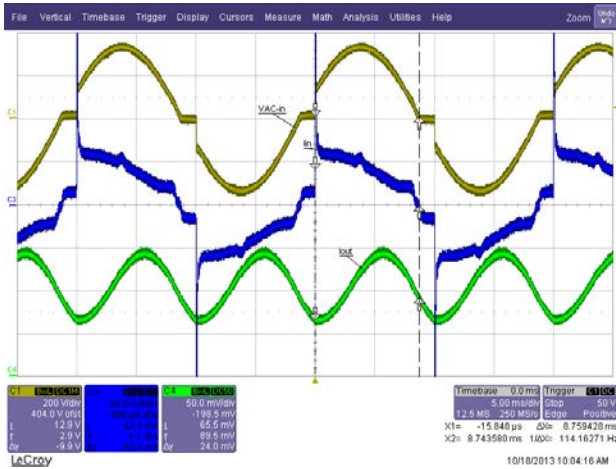
**Figure 131** – Full Conduction from Distorted AC Line 230 V / 50 Hz.  
 Ch1: V<sub>IN</sub>; 200 V / div.  
 Ch3: I<sub>IN</sub>; 50 mA / div.  
 Ch4: I<sub>OUT</sub>; 50 mA / div.  
 Time Scale: 5 ms / div.



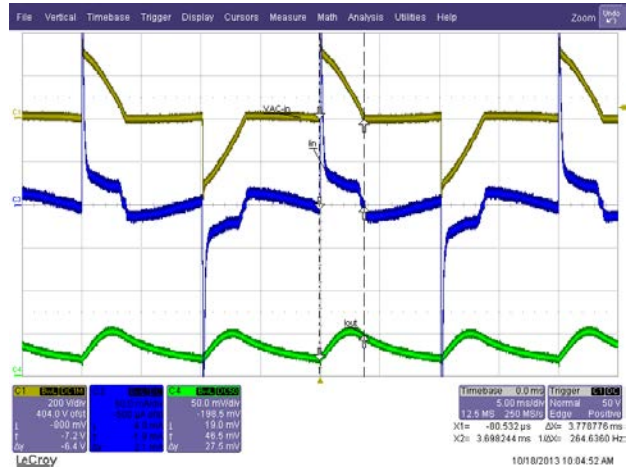
**Figure 132** – Minimum Conduction from Distorted AC Line 230 V / 50 Hz.  
 Ch1: V<sub>IN</sub>; 200 V / div.  
 Ch3: I<sub>IN</sub>; 50 mA / div.  
 Ch4: I<sub>OUT</sub>; 50 mA / div.  
 Time Scale: 5 ms / div.



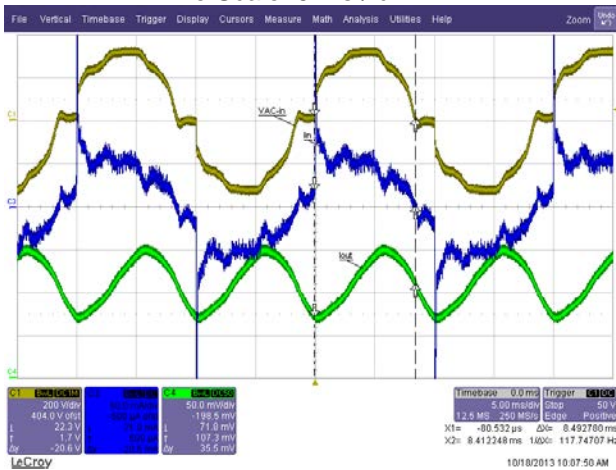
Dimmer: Niko 310-014



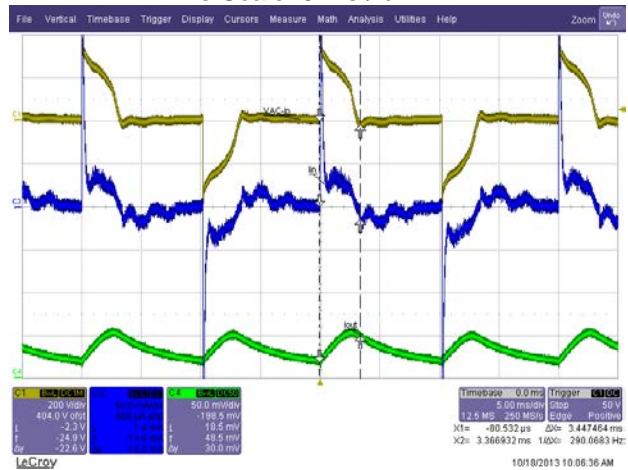
**Figure 133** – Full Conduction from Regulated AC Input 230 V / 50 Hz.  
 Ch1:  $V_{IN}$ ; 200 V / div.  
 Ch3:  $I_{IN}$ ; 50 mA / div.  
 Ch4:  $I_{OUT}$ ; 50 mA / div.  
 Time Scale: 5 ms / div.



**Figure 134** – Minimum Conduction from Regulated AC Input 230 V / 50 Hz.  
 Ch1:  $V_{IN}$ ; 200 V / div.  
 Ch3:  $I_{IN}$ ; 50 mA / div.  
 Ch4:  $I_{OUT}$ ; 50 mA / div.  
 Time Scale: 5 ms / div.



**Figure 135** – Full Conduction from Distorted AC Line 230 V / 50 Hz.  
 Ch1:  $V_{IN}$ ; 200 V / div.  
 Ch3:  $I_{IN}$ ; 50 mA / div.  
 Ch4:  $I_{OUT}$ ; 50 mA / div.  
 Time Scale: 5 ms / div.

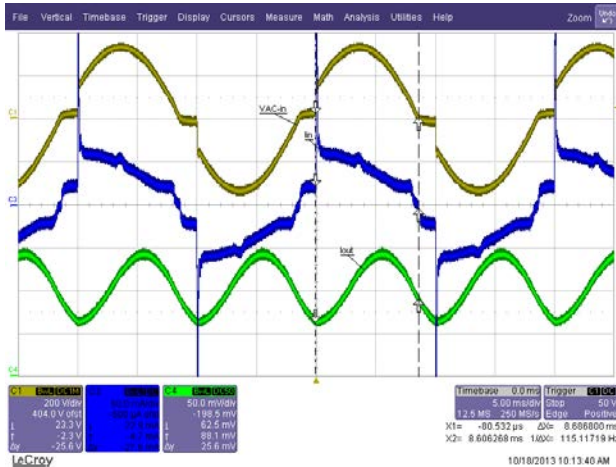


**Figure 136** – Minimum Conduction from Distorted AC Line 230 V / 50 Hz.  
 Ch1:  $V_{IN}$ ; 200 V / div.  
 Ch3:  $I_{IN}$ ; 50 mA / div.  
 Ch4:  $I_{OUT}$ ; 50 mA / div.  
 Time Scale: 5 ms / div.

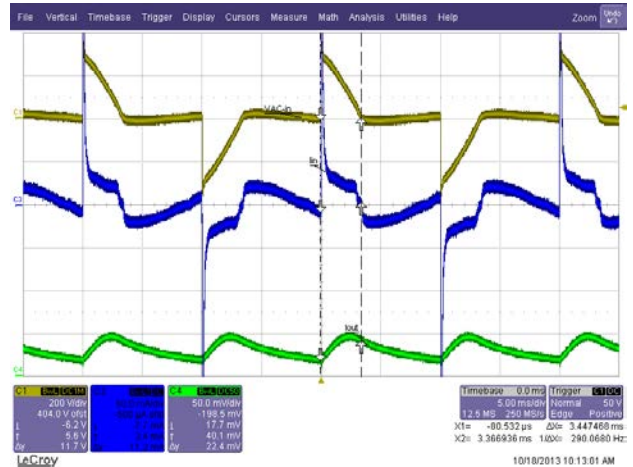




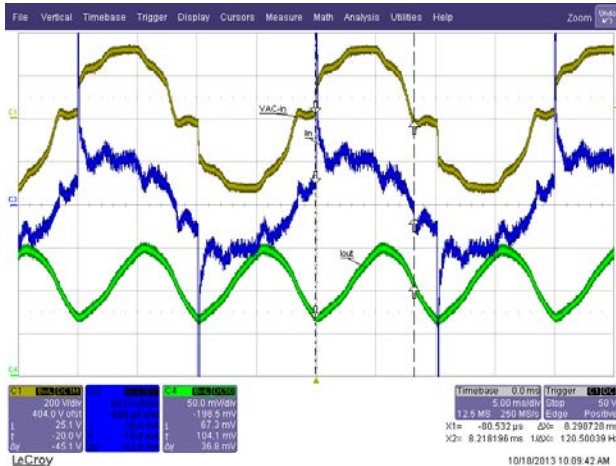
Dimmer: Niko 310-016



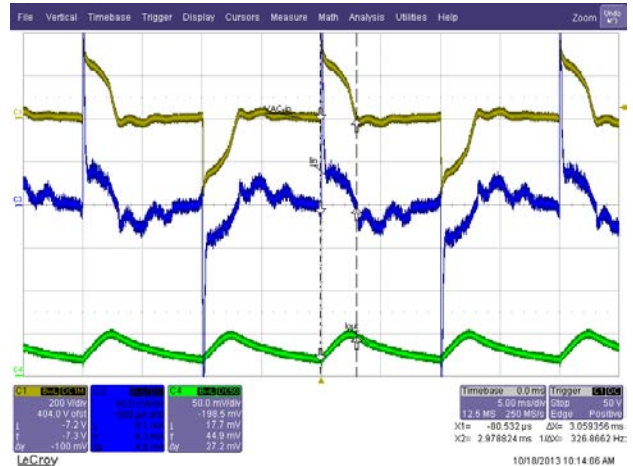
**Figure 137** – Full Conduction from Regulated AC Input 230 V / 50 Hz.  
 Ch1:  $V_{IN}$ ; 200 V / div.  
 Ch3:  $I_{IN}$ ; 50 mA / div.  
 Ch4:  $I_{OUT}$ ; 50 mA / div.  
 Time Scale: 5 ms / div.



**Figure 138** – Minimum Conduction from Regulated AC Input 230 V / 50 Hz.  
 Ch1:  $V_{IN}$ ; 200 V / div.  
 Ch3:  $I_{IN}$ ; 50 mA / div.  
 Ch4:  $I_{OUT}$ ; 50 mA / div.  
 Time Scale: 5 ms / div.



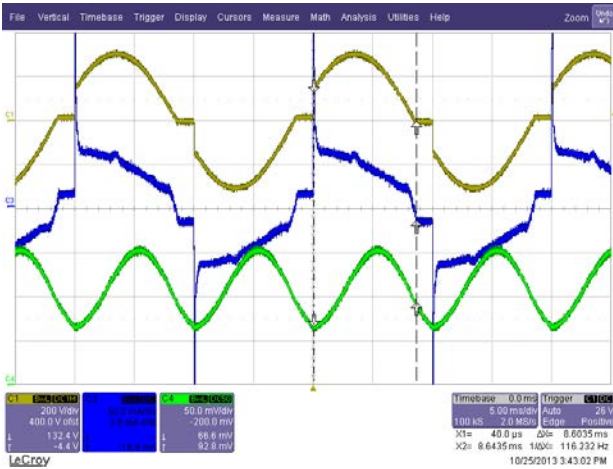
**Figure 139** – Full Conduction from Distorted AC Line 230 V / 50 Hz.  
 Ch1:  $V_{IN}$ ; 200 V / div.  
 Ch3:  $I_{IN}$ ; 50 mA / div.  
 Ch4:  $I_{OUT}$ ; 50 mA / div.  
 Time Scale: 5 ms / div.



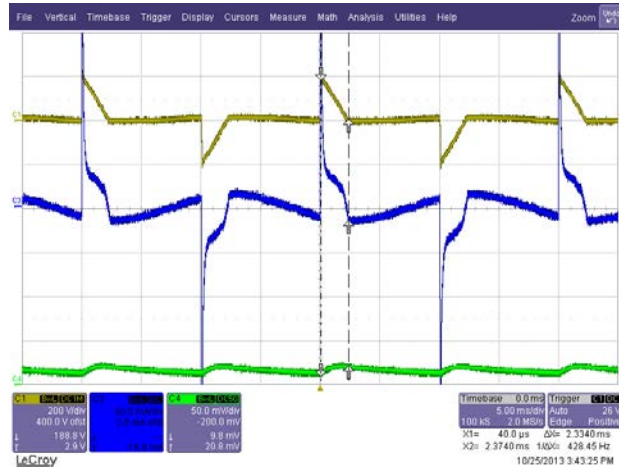
**Figure 140** – Minimum Conduction from Distorted AC Line 230 V / 50 Hz.  
 Ch1:  $V_{IN}$ ; 200 V / div.  
 Ch3:  $I_{IN}$ ; 50 mA / div.  
 Ch4:  $I_{OUT}$ ; 50 mA / div.  
 Time Scale: 5 ms / div.



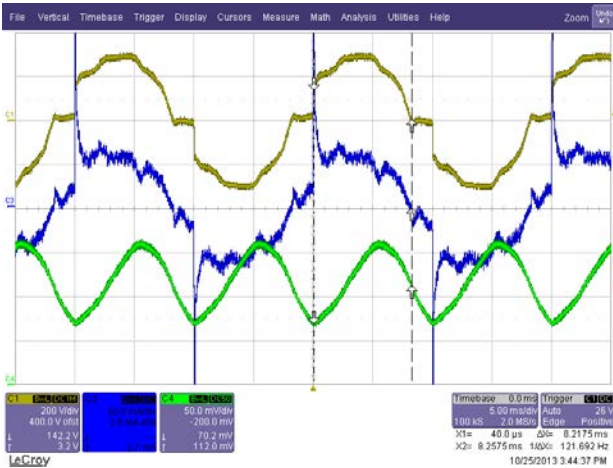
Dimmer: Busch 2250



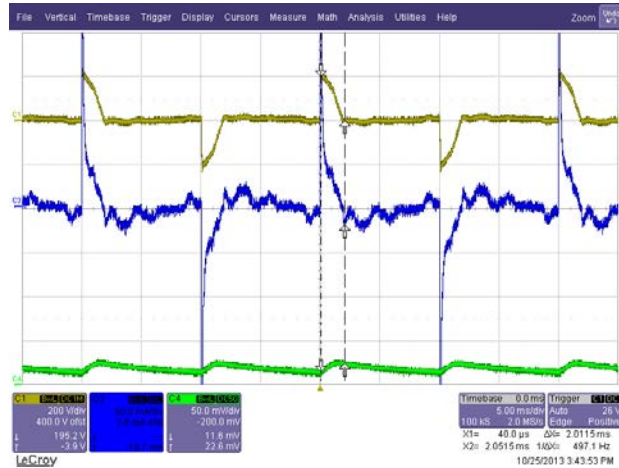
**Figure 141** – Full Conduction from Regulated AC Input 230 V / 50 Hz.  
 Ch1:  $V_{IN}$ ; 200 V / div.  
 Ch3:  $I_{IN}$ ; 50 mA / div.  
 Ch4:  $I_{OUT}$ ; 50 mA / div.  
 Time Scale: 5 ms / div.



**Figure 142** – Minimum Conduction from Regulated AC Input 230 V / 50 Hz.  
 Ch1:  $V_{IN}$ ; 200 V / div.  
 Ch3:  $I_{IN}$ ; 50 mA / div.  
 Ch4:  $I_{OUT}$ ; 50 mA / div.  
 Time Scale: 5 ms / div.



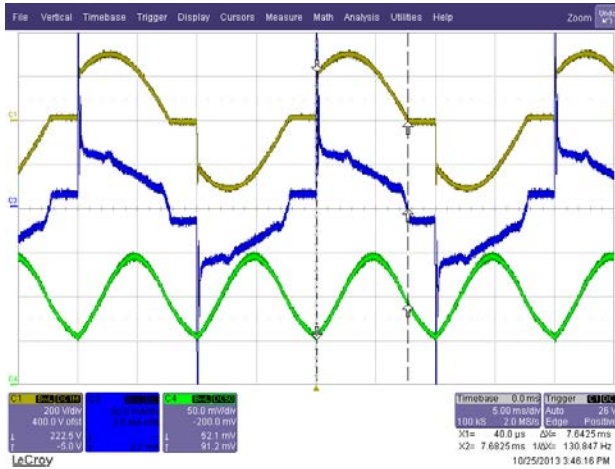
**Figure 143** – Full Conduction from Distorted AC Line 230 V / 50 Hz.  
 Ch1:  $V_{IN}$ ; 200 V / div.  
 Ch3:  $I_{IN}$ ; 50 mA / div.  
 Ch4:  $I_{OUT}$ ; 50 mA / div.  
 Time Scale: 5 ms / div.



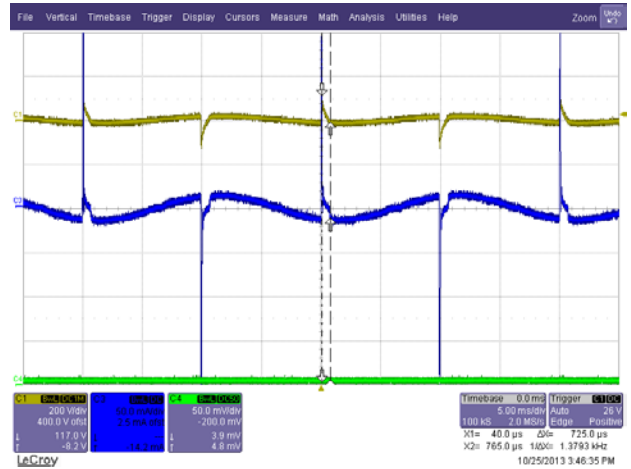
**Figure 144** – Minimum Conduction from Distorted AC Line 230 V / 50 Hz.  
 Ch1:  $V_{IN}$ ; 200 V / div.  
 Ch3:  $I_{IN}$ ; 50 mA / div.  
 Ch4:  $I_{OUT}$ ; 50 mA / div.  
 Time Scale: 5 ms / div.



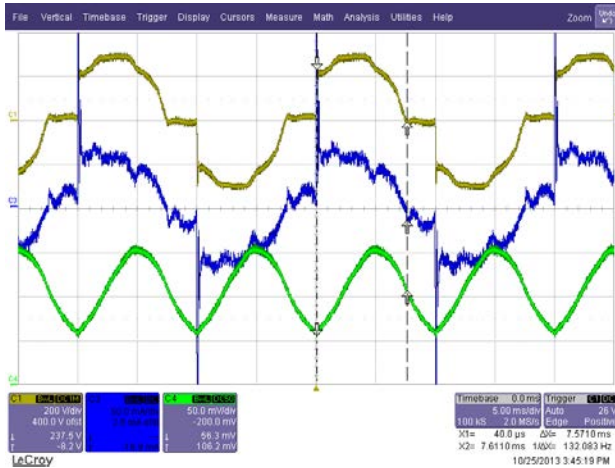
Dimmer: PEHA 400 W



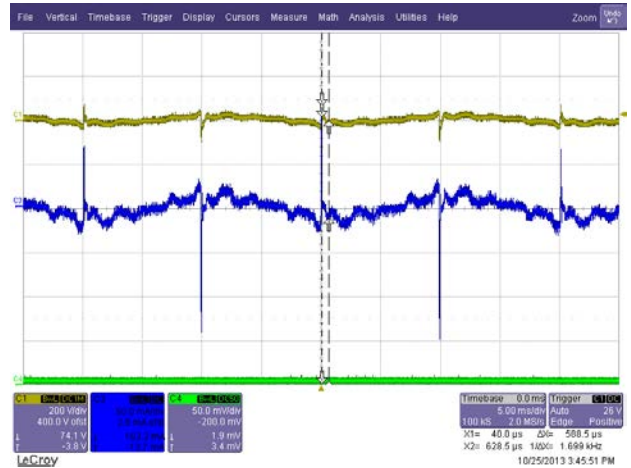
**Figure 145** – Full Conduction from Regulated AC Input 230 V / 50 Hz.  
 Ch1:  $V_{IN}$ ; 200 V / div.  
 Ch3:  $I_{IN}$ ; 50 mA / div.  
 Ch4:  $I_{OUT}$ ; 50mA / div.  
 Time Scale: 5 ms / div.



**Figure 146** – Minimum Conduction from Regulated AC Input 230 V / 50 Hz.  
 Ch1:  $V_{IN}$ ; 200 V / div.  
 Ch3:  $I_{IN}$ ; 50 mA / div.  
 Ch4:  $I_{OUT}$ ; 50 mA / div.  
 Time Scale: 5 ms / div.



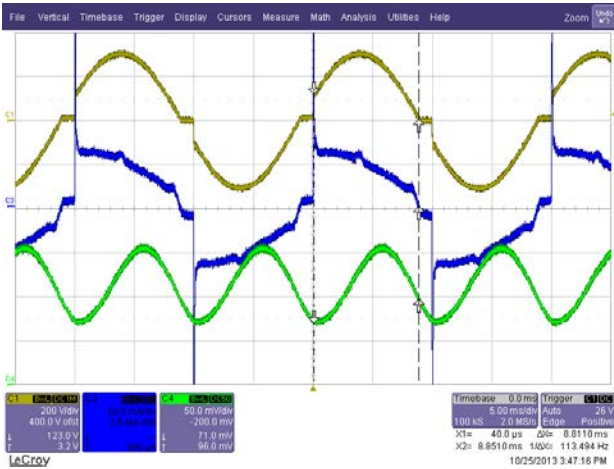
**Figure 147** – Full Conduction from Distorted AC Line 230 V / 50 Hz.  
 Ch1:  $V_{IN}$ ; 200 V / div.  
 Ch3:  $I_{IN}$ ; 50 mA / div.  
 Ch4:  $I_{OUT}$ ; 50 mA / div.  
 Time Scale: 5 ms / div.



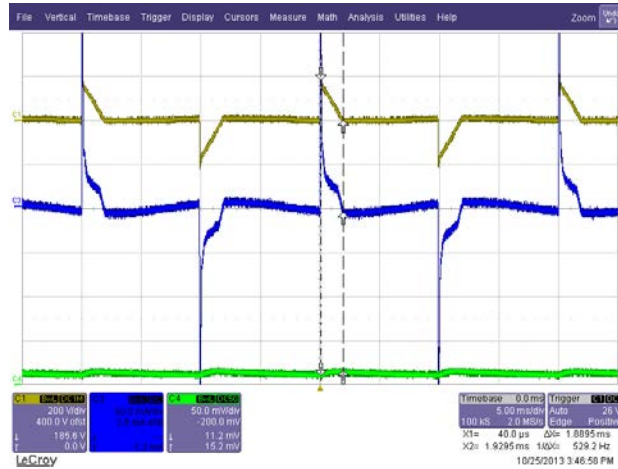
**Figure 148** – Minimum Conduction from Distorted AC Line 230 V / 50 Hz.  
 Ch1:  $V_{IN}$ ; 200 V / div.  
 Ch3:  $I_{IN}$ ; 50 mA / div.  
 Ch4:  $I_{OUT}$ ; 50 mA / div.  
 Time Scale: 5 ms / div.



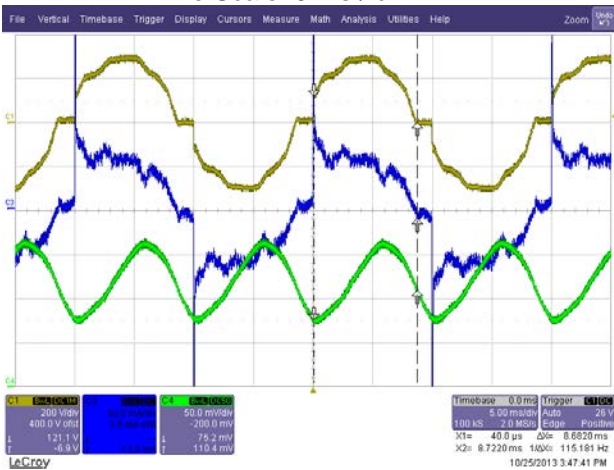
Dimmer: Merten 572499



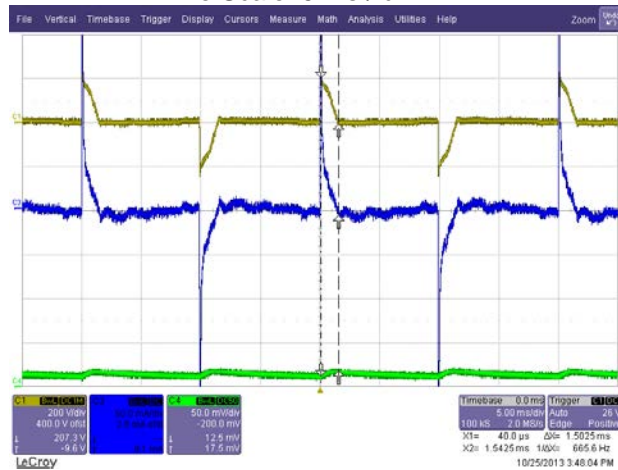
**Figure 149** – Full Conduction from Regulated AC Input 230 V / 50 Hz.  
 Ch1:  $V_{IN}$ ; 200 V / div.  
 Ch3:  $I_{IN}$ ; 50 mA / div.  
 Ch4:  $I_{OUT}$ ; 50 mA / div.  
 Time Scale: 5 ms / div.



**Figure 150** – Minimum Conduction from Regulated AC Input 230 V / 50 Hz.  
 Ch1:  $V_{IN}$ ; 200 V / div.  
 Ch3:  $I_{IN}$ ; 50 mA / div.  
 Ch4:  $I_{OUT}$ ; 50 mA / div.  
 Time Scale: 5 ms / div.

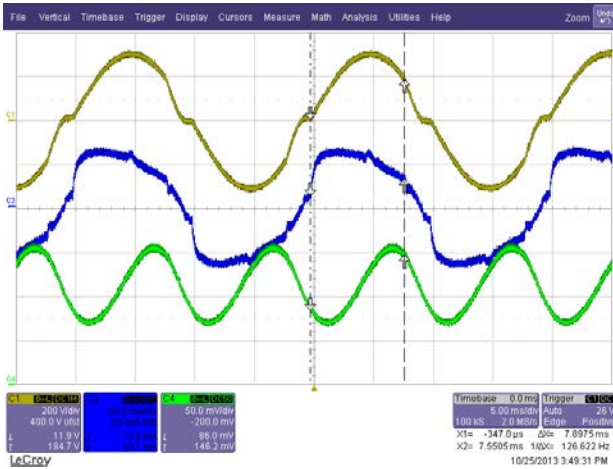


**Figure 151** – Full Conduction from Distorted AC Line 230 V / 50 Hz.  
 Ch1:  $V_{IN}$ ; 200 V / div.  
 Ch3:  $I_{IN}$ ; 50 mA / div.  
 Ch4:  $I_{OUT}$ ; 50 mA / div.  
 Time Scale: 5 ms / div.

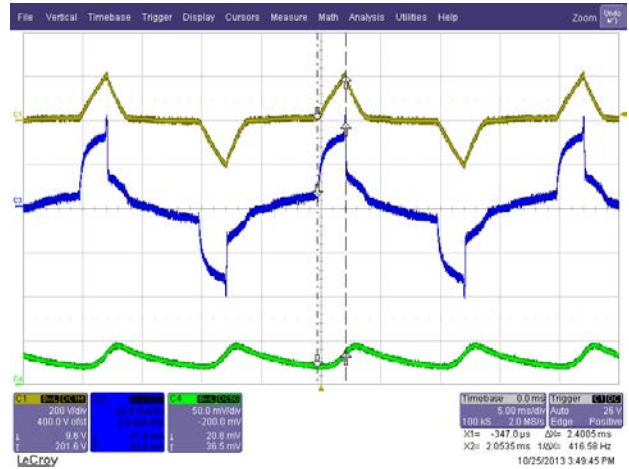


**Figure 152** – Minimum Conduction from Distorted AC Line 230 V / 50 Hz.  
 Ch1:  $V_{IN}$ ; 200 V / div.  
 Ch3:  $I_{IN}$ ; 50 mA / div.  
 Ch4:  $I_{OUT}$ ; 50 mA / div.  
 Time Scale: 5 ms / div.

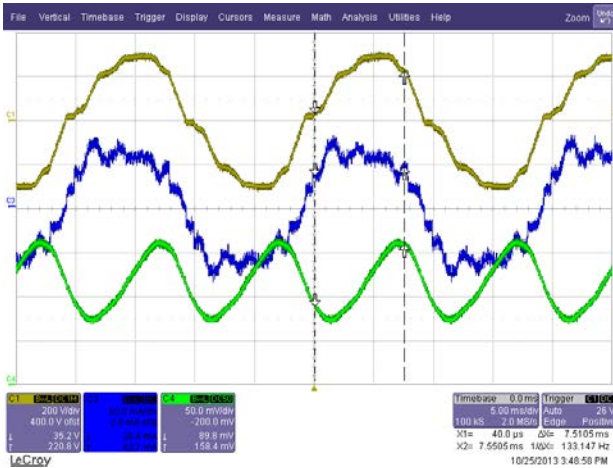
Dimmer: Busch 6513



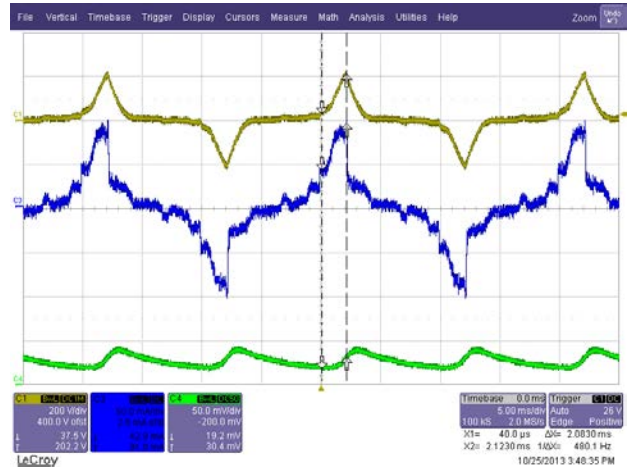
**Figure 153** – Full Conduction from Regulated AC Input 230 V / 50 Hz.  
 Ch1:  $V_{IN}$ ; 200 V / div.  
 Ch3:  $I_{IN}$ ; 50 mA / div.  
 Ch4:  $I_{OUT}$ ; 50 mA / div.  
 Time Scale: 5 ms / div.



**Figure 154** – Minimum Conduction from Regulated AC Input 230 V / 50 Hz.  
 Ch1:  $V_{IN}$ ; 200 V / div.  
 Ch3:  $I_{IN}$ ; 50 mA / div.  
 Ch4:  $I_{OUT}$ ; 50 mA / div.  
 Time Scale: 5 ms / div.



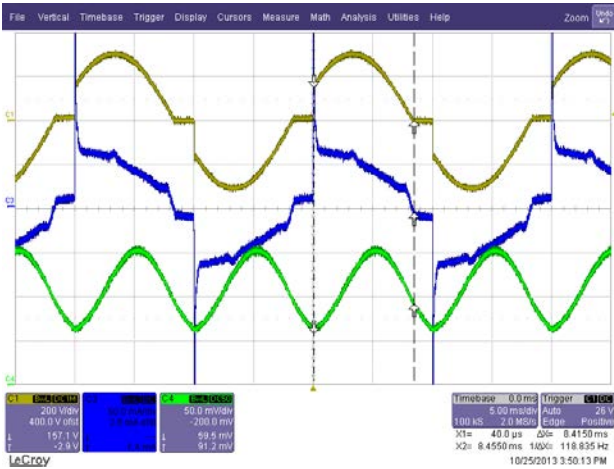
**Figure 155** – Full Conduction from Distorted AC Line 230 V / 50 Hz.  
 Ch1:  $V_{IN}$ ; 200 V / div.  
 Ch3:  $I_{IN}$ ; 50 mA / div.  
 Ch4:  $I_{OUT}$ ; 50 mA / div.  
 Time Scale: 5 ms / div.



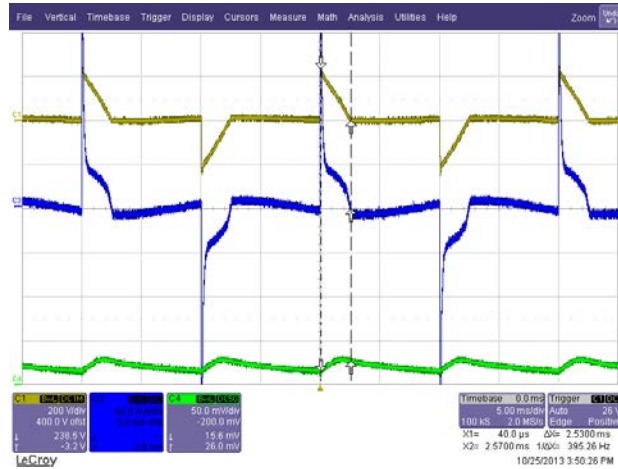
**Figure 156** – Minimum Conduction from Distorted AC Line 230 V / 50 Hz.  
 Ch1:  $V_{IN}$ ; 200 V / div.  
 Ch3:  $I_{IN}$ ; 50 mA / div.  
 Ch4:  $I_{OUT}$ ; 50 mA / div.  
 Time Scale: 5 ms / div.



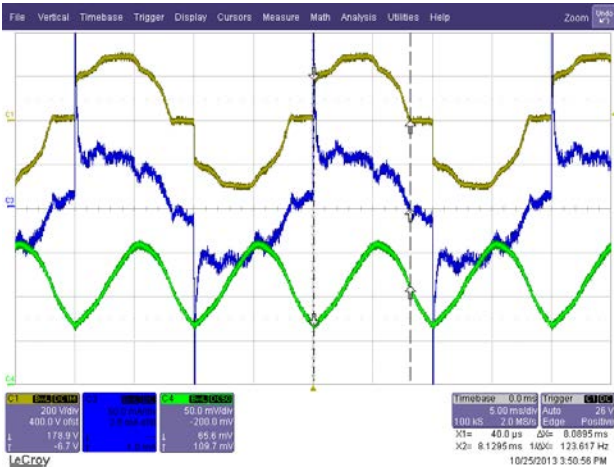
Dimmer: Berker 2875



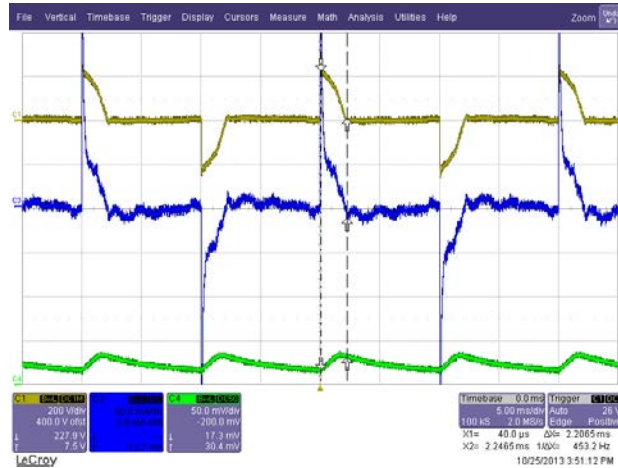
**Figure 157** – Full Conduction from Regulated AC Input 230 V / 50 Hz.  
 Ch1:  $V_{IN}$ ; 200 V / div.  
 Ch3:  $I_{IN}$ ; 50 mA / div.  
 Ch4:  $I_{OUT}$ ; 50 mA / div.  
 Time Scale: 5 ms / div.



**Figure 158** – Minimum Conduction from Regulated AC Input 230 V / 50 Hz.  
 Ch1:  $V_{IN}$ ; 200 V / div.  
 Ch3:  $I_{IN}$ ; 50 mA / div.  
 Ch4:  $I_{OUT}$ ; 50 mA / div.  
 Time Scale: 5 ms / div.



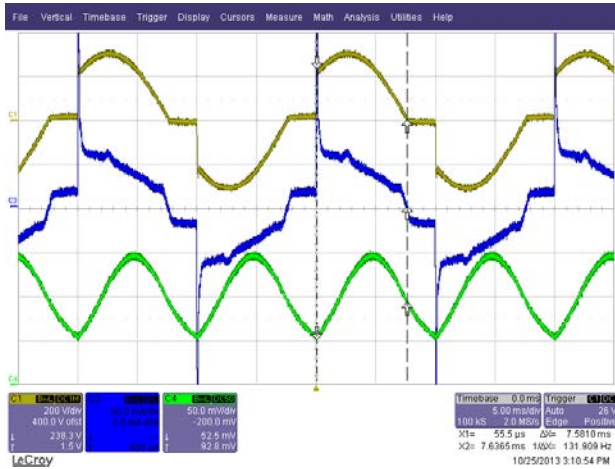
**Figure 159** – Full Conduction from Distorted AC Line 230 V / 50 Hz.  
 Ch1:  $V_{IN}$ ; 200 V / div.  
 Ch3:  $I_{IN}$ ; 50 mA / div.  
 Ch4:  $I_{OUT}$ ; 50 mA / div.  
 Time Scale: 5 ms / div.



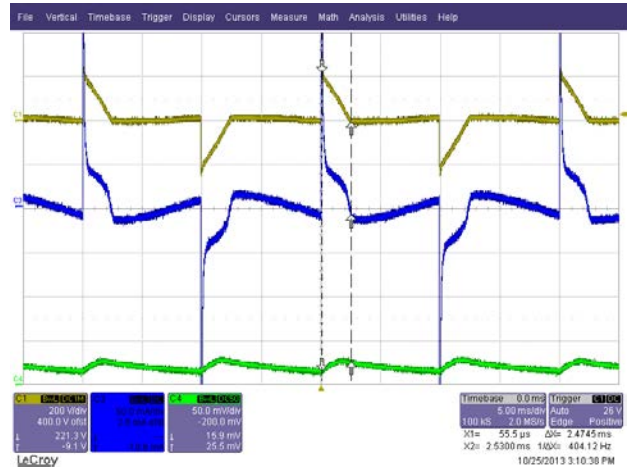
**Figure 160** – Minimum Conduction from Distorted AC Line 230 V / 50 Hz.  
 Ch1:  $V_{IN}$ ; 200 V / div.  
 Ch3:  $I_{IN}$ ; 50 mA / div.  
 Ch4:  $I_{OUT}$ ; 50 mA / div.  
 Time Scale: 5 ms / div.



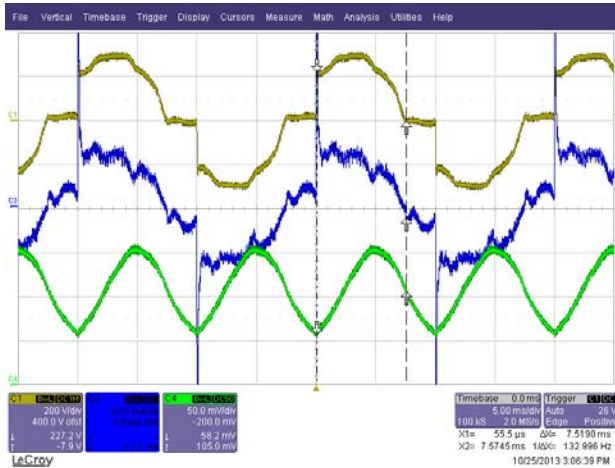
Dimmer: Berker 2830-10



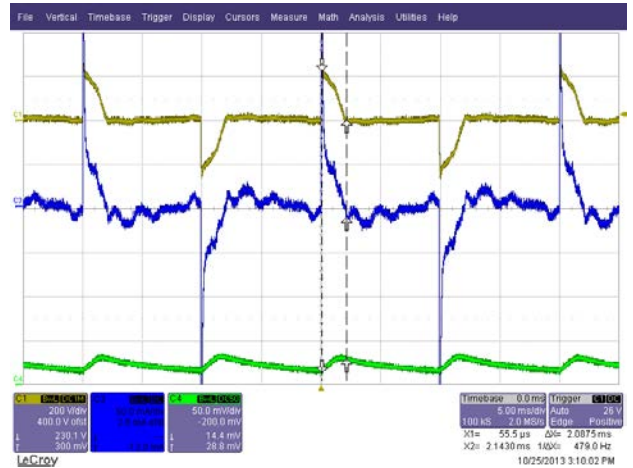
**Figure 161** – Full Conduction from Regulated AC Input 230 V / 50 Hz.  
 Ch1:  $V_{IN}$ ; 200 V / div.  
 Ch3:  $I_{IN}$ ; 50 mA / div.  
 Ch4:  $I_{OUT}$ ; 50 mA / div.  
 Time Scale: 5 ms / div.



**Figure 162** – Minimum Conduction from Regulated AC Input 230 V / 50 Hz.  
 Ch1:  $V_{IN}$ ; 200 V / div.  
 Ch3:  $I_{IN}$ ; 50 mA / div.  
 Ch4:  $I_{OUT}$ ; 50 mA / div.  
 Time Scale: 5 ms / div.



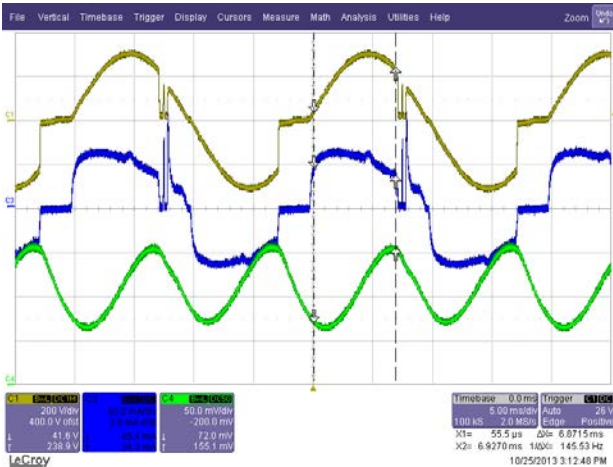
**Figure 163** – Full Conduction from Distorted AC Line 230 V / 50 Hz.  
 Ch1:  $V_{IN}$ ; 200 V / div.  
 Ch3:  $I_{IN}$ ; 50 mA / div.  
 Ch4:  $I_{OUT}$ ; 50 mA / div.  
 Time Scale: 5 ms / div.



**Figure 164** – Minimum Conduction from Distorted AC Line 230 V / 50 Hz.  
 Ch1:  $V_{IN}$ ; 200 V / div.  
 Ch3:  $I_{IN}$ ; 50 mA / div.  
 Ch4:  $I_{OUT}$ ; 50 mA / div.  
 Time Scale: 5 ms / div.

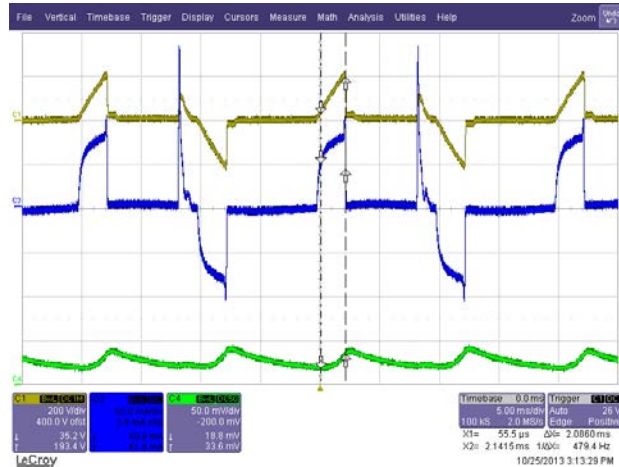


Dimmer: Busch 6591-101



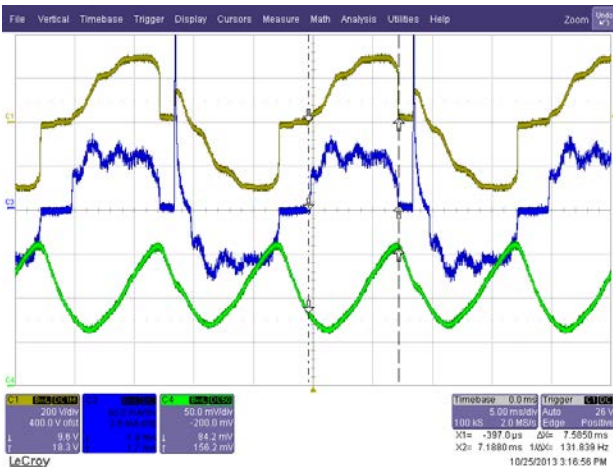
**Figure 165** – Full Conduction from Regulated AC Input 230 V / 50 Hz. Natural characteristic of the dimmer is asymmetric.

Ch1:  $V_{IN}$ ; 200 V / div.  
 Ch3:  $I_{IN}$ ; 50 mA / div.  
 Ch4:  $I_{OUT}$ ; 50 mA / div.  
 Time Scale: 5 ms / div.



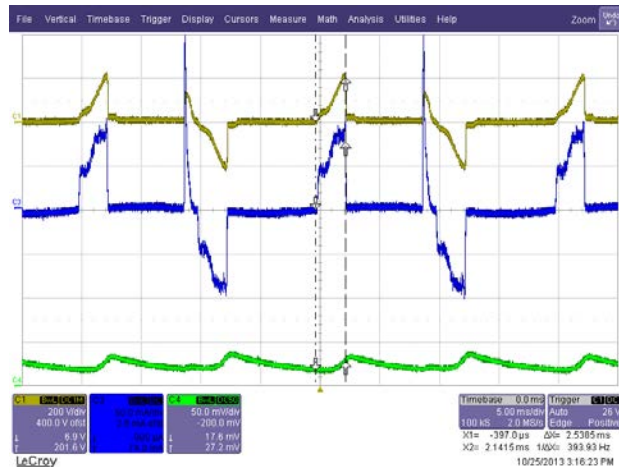
**Figure 166** – Minimum Conduction from Regulated AC Input 230 V / 50 Hz.

Ch1:  $V_{IN}$ ; 200 V / div.  
 Ch3:  $I_{IN}$ ; 50 mA / div.  
 Ch4:  $I_{OUT}$ ; 50 mA / div.  
 Time Scale: 5 ms / div.



**Figure 167** – Full Conduction from Distorted AC Line 230 V / 50 Hz.

Ch1:  $V_{IN}$ ; 200 V / div.  
 Ch3:  $I_{IN}$ ; 50 mA / div.  
 Ch4:  $I_{OUT}$ ; 50 mA / div.  
 Time Scale: 5 ms / div.

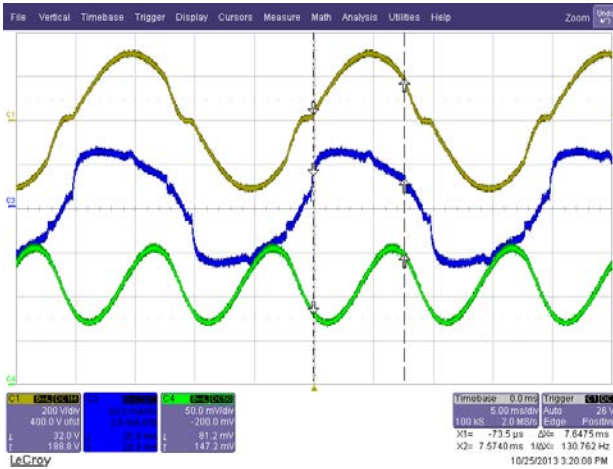


**Figure 168** – Minimum Conduction from Distorted AC Line 230 V / 50 Hz.

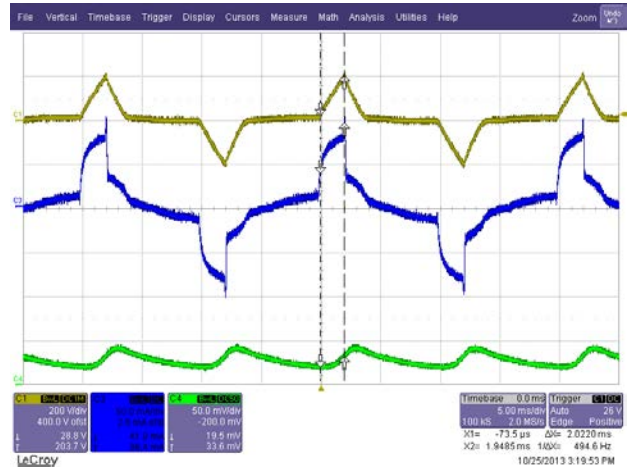
Ch1:  $V_{IN}$ ; 200 V / div.  
 Ch3:  $I_{IN}$ ; 50 mA / div.  
 Ch4:  $I_{OUT}$ ; 50 mA / div.  
 Time Scale: 5 ms / div.



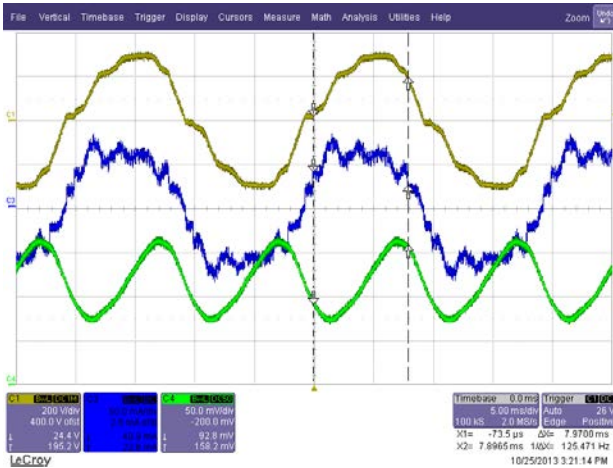
Dimmer: Busch 6513 U-102



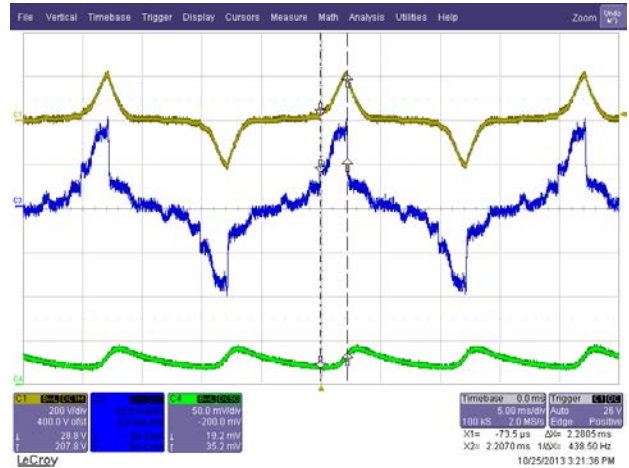
**Figure 169** – Full Conduction from Regulated AC Input 230 V / 50 Hz.  
 Ch1:  $V_{IN}$ ; 200 V / div.  
 Ch3:  $I_{IN}$ ; 50 mA / div.  
 Ch4:  $I_{OUT}$ ; 50 mA / div.  
 Time Scale: 5 ms / div.



**Figure 170** – Minimum Conduction from Regulated AC Input 230 V / 50 Hz.  
 Ch1:  $V_{IN}$ ; 200 V / div.  
 Ch3:  $I_{IN}$ ; 50 mA / div.  
 Ch4:  $I_{OUT}$ ; 50 mA / div.  
 Time Scale: 5 ms / div.



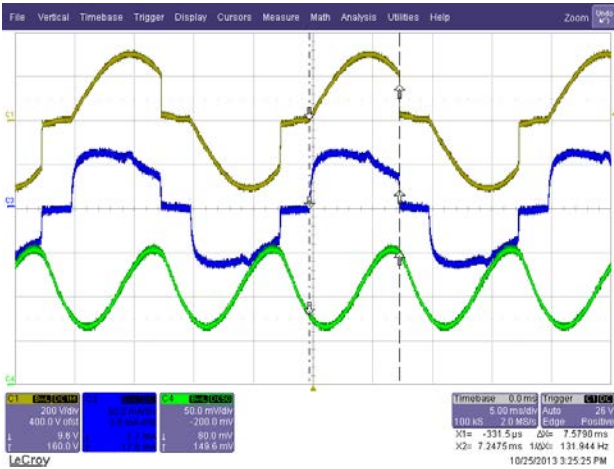
**Figure 171** – Full Conduction from Distorted AC Line 230 V / 50 Hz.  
 Ch1:  $V_{IN}$ ; 200 V / div.  
 Ch3:  $I_{IN}$ ; 50 mA / div.  
 Ch4:  $I_{OUT}$ ; 50 mA / div.  
 Time Scale: 5 ms / div.



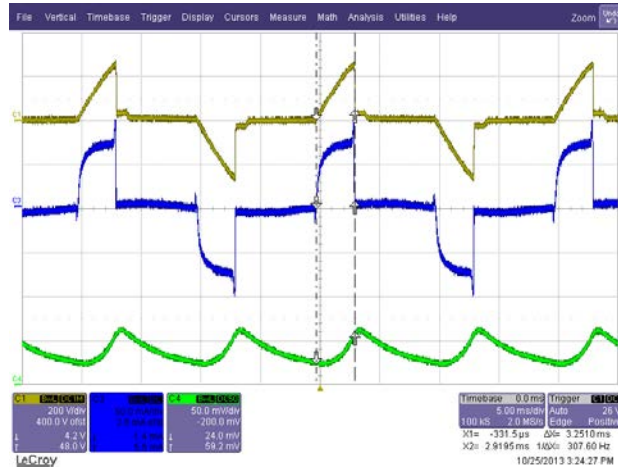
**Figure 172** – Minimum Conduction from Distorted AC Line 230 V / 50 Hz.  
 Ch1:  $V_{IN}$ ; 200 V / div.  
 Ch3:  $I_{IN}$ ; 50 mA / div.  
 Ch4:  $I_{OUT}$ ; 50 mA / div.  
 Time Scale: 5 ms / div.



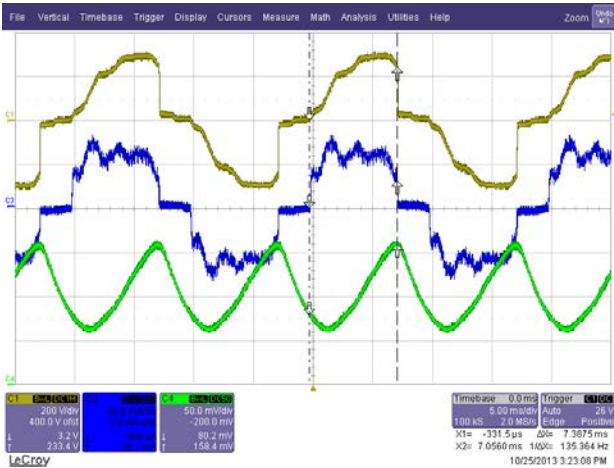
Dimmer: PEHA 433HAB 0A



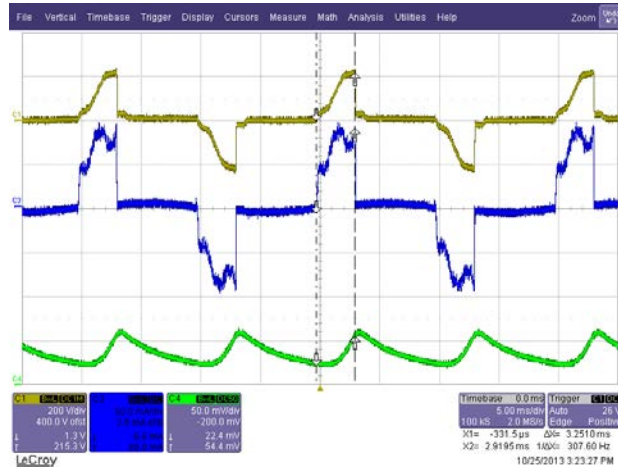
**Figure 173** – Full Conduction from Regulated AC Input 230 V / 50 Hz.  
 Ch1: V<sub>IN</sub>; 200 V / div.  
 Ch3: I<sub>IN</sub>; 50 mA / div.  
 Ch4: I<sub>OUT</sub>; 50 mA / div.  
 Time Scale: 5 ms / div.



**Figure 174** – Minimum Conduction from Regulated AC Input 230 V / 50 Hz.  
 Ch1: V<sub>IN</sub>; 200 V / div.  
 Ch3: I<sub>IN</sub>; 50 mA / div.  
 Ch4: I<sub>OUT</sub>; 50 mA / div.  
 Time Scale: 5 ms / div.

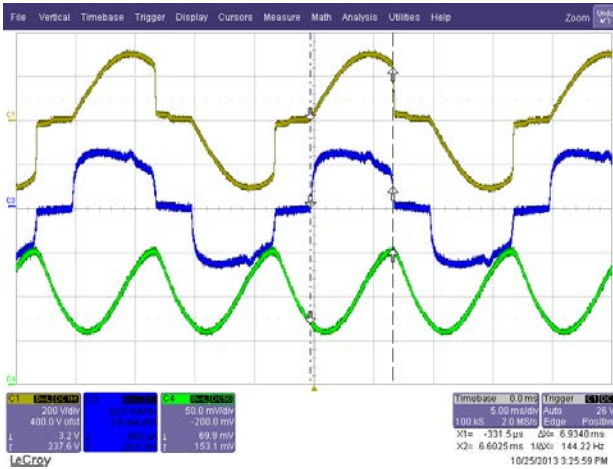


**Figure 175** – Full Conduction from Distorted AC Line 230 V / 50 Hz.  
 Ch1: V<sub>IN</sub>; 200 V / div.  
 Ch3: I<sub>IN</sub>; 50 mA / div.  
 Ch4: I<sub>OUT</sub>; 50 mA / div.  
 Time Scale: 5 ms / div.

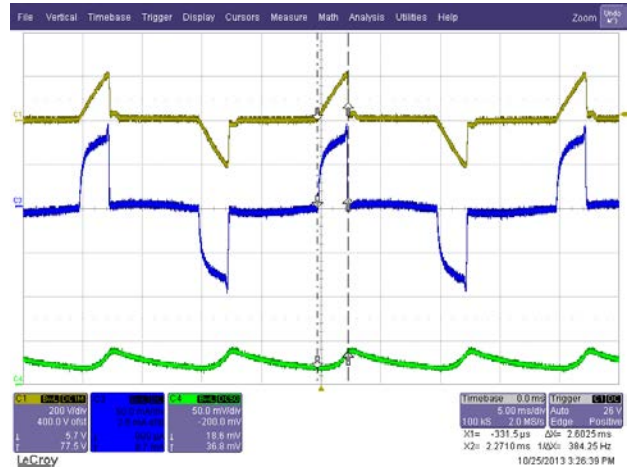


**Figure 176** – Minimum Conduction from Distorted AC Line 230 V / 50 Hz.  
 Ch1: V<sub>IN</sub>; 200 V / div.  
 Ch3: I<sub>IN</sub>; 50 mA / div.  
 Ch4: I<sub>OUT</sub>; 50 mA / div.  
 Time Scale: 5 ms / div.

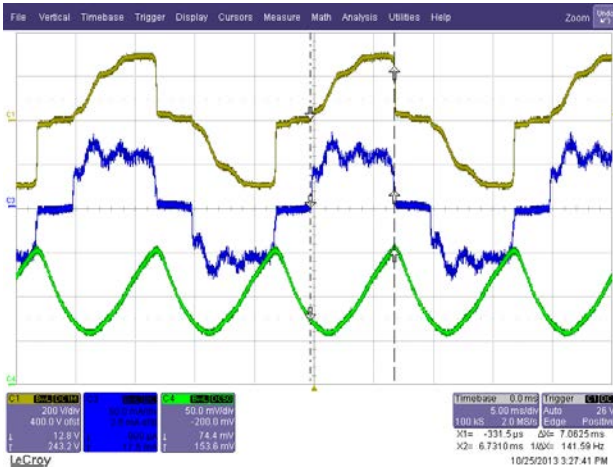
Dimmer: PEHA 433HAB 0A



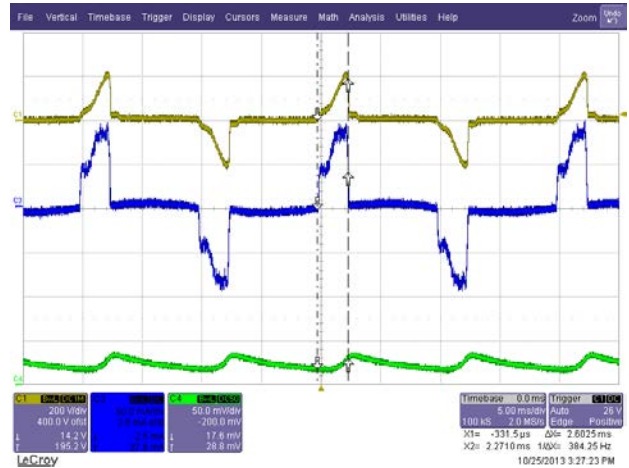
**Figure 177** – Full Conduction from Regulated AC Input 230 V / 50 Hz.  
 Ch1:  $V_{IN}$ ; 200 V / div.  
 Ch3:  $I_{IN}$ ; 50 mA / div.  
 Ch4:  $I_{OUT}$ ; 50 mA / div.  
 Time Scale: 5 ms / div.



**Figure 178** – Minimum Conduction from Regulated AC Input 230 V / 50 Hz.  
 Ch1:  $V_{IN}$ ; 200 V / div.  
 Ch3:  $I_{IN}$ ; 50 mA / div.  
 Ch4:  $I_{OUT}$ ; 50 mA / div.  
 Time Scale: 5 ms / div.



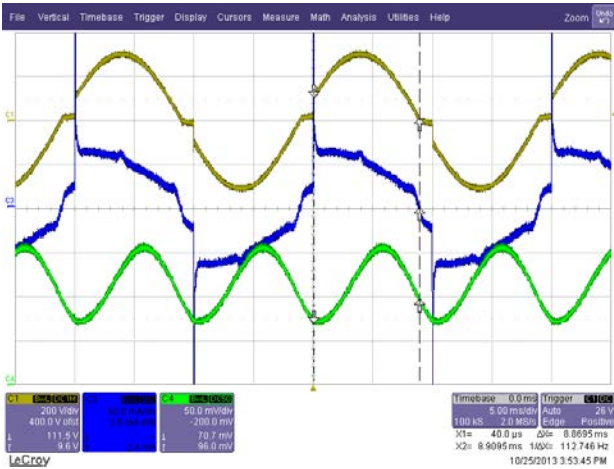
**Figure 179** – Full Conduction from Distorted AC Line 230 V / 50 Hz.  
 Ch1:  $V_{IN}$ ; 200 V / div.  
 Ch3:  $I_{IN}$ ; 50 mA / div.  
 Ch4:  $I_{OUT}$ ; 50 mA / div.  
 Time Scale: 5 ms / div.



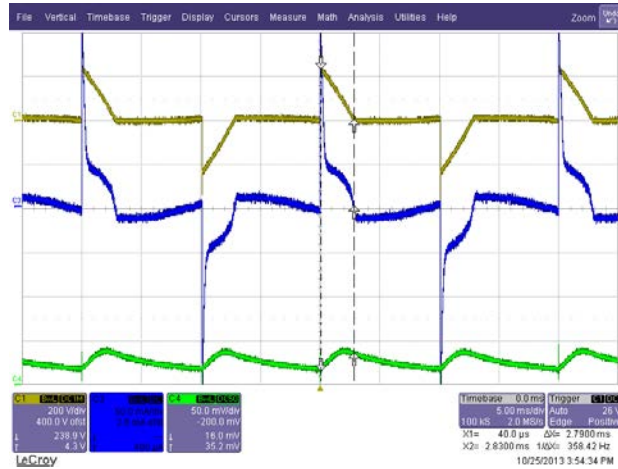
**Figure 180** – Minimum Conduction from Distorted AC Line 230 V / 50 Hz.  
 Ch1:  $V_{IN}$ ; 200 V / div.  
 Ch3:  $I_{IN}$ ; 50 mA / div.  
 Ch4:  $I_{OUT}$ ; 50 mA / div.  
 Time Scale: 5 ms /



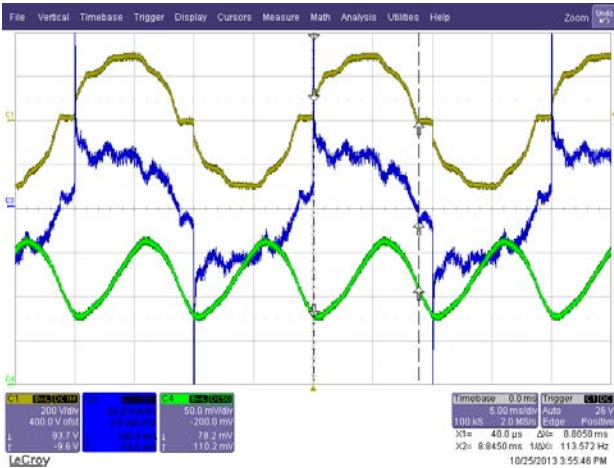
Dimmer: Relco RM34DMA



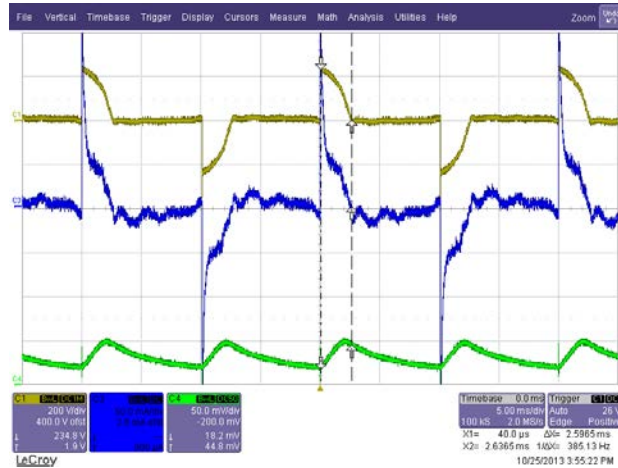
**Figure 181** – Full Conduction from Regulated AC Input 230 V / 50 Hz.  
 Ch1:  $V_{IN}$ ; 200 V / div.  
 Ch3:  $I_{IN}$ ; 50 mA / div.  
 Ch4:  $I_{OUT}$ ; 50 mA / div.  
 Time Scale: 5 ms / div.



**Figure 182** – Minimum Conduction from Regulated AC Input 230 V / 50 Hz.  
 Ch1:  $V_{IN}$ ; 200 V / div.  
 Ch3:  $I_{IN}$ ; 50 mA / div.  
 Ch4:  $I_{OUT}$ ; 50 mA / div.  
 Time Scale: 5 ms / div.



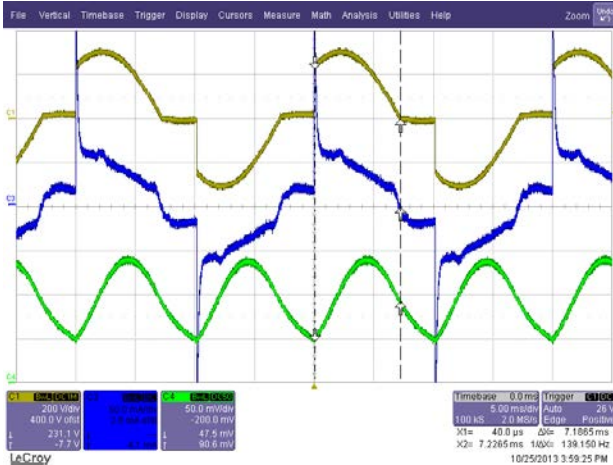
**Figure 183** – Full Conduction from Distorted AC Line 230 V / 50 Hz.  
 Ch1:  $V_{IN}$ ; 200 V / div.  
 Ch3:  $I_{IN}$ ; 50 mA / div.  
 Ch4:  $I_{OUT}$ ; 50 mA / div.  
 Time Scale: 5 ms / div.



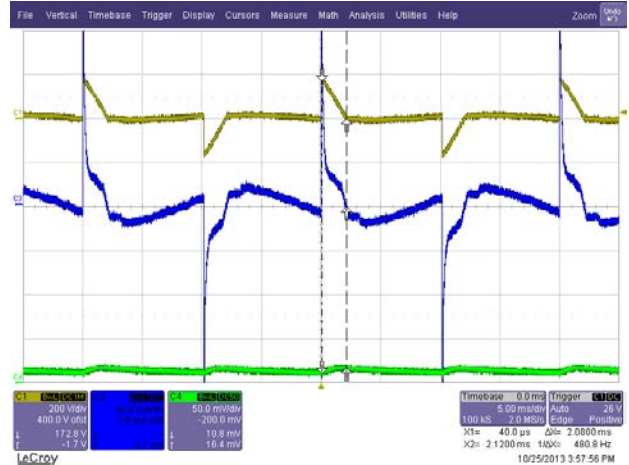
**Figure 184** – Minimum Conduction from Distorted AC Line 230 V / 50 Hz.  
 Ch1:  $V_{IN}$ ; 200 V / div.  
 Ch3:  $I_{IN}$ ; 50 mA / div.  
 Ch4:  $I_{OUT}$ ; 50 mA / div.  
 Time Scale: 5ms / div.



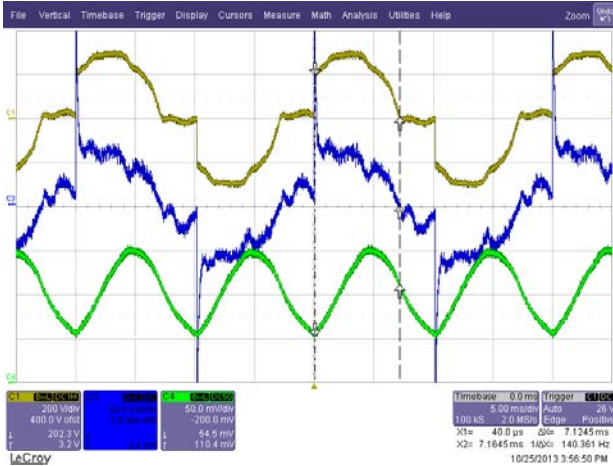
Dimmer: Relco RTM34LED DAXS



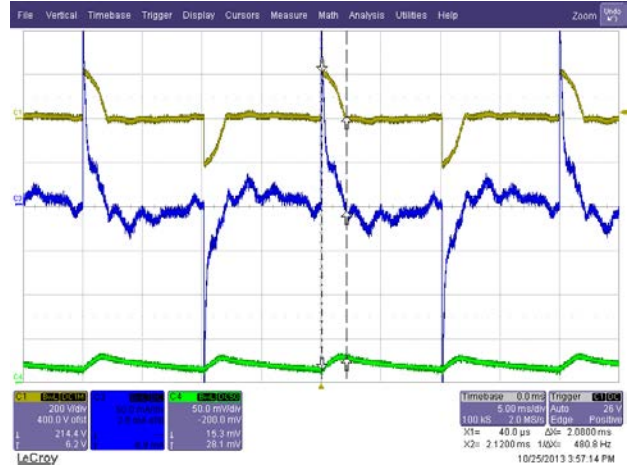
**Figure 185** – Full Conduction from Regulated AC Input 230 V / 50 Hz.  
 Ch1:  $V_{IN}$ ; 200 V / div.  
 Ch3:  $I_{IN}$ ; 50 mA / div.  
 Ch4:  $I_{OUT}$ ; 50 mA / div.  
 Time Scale: 5 ms / div.



**Figure 186** – Minimum Conduction from Regulated AC Input 230 V / 50 Hz.  
 Ch1:  $V_{IN}$ ; 200 V / div.  
 Ch3:  $I_{IN}$ ; 50 mA / div.  
 Ch4:  $I_{OUT}$ ; 50 mA / div.  
 Time Scale: 5 ms / div.



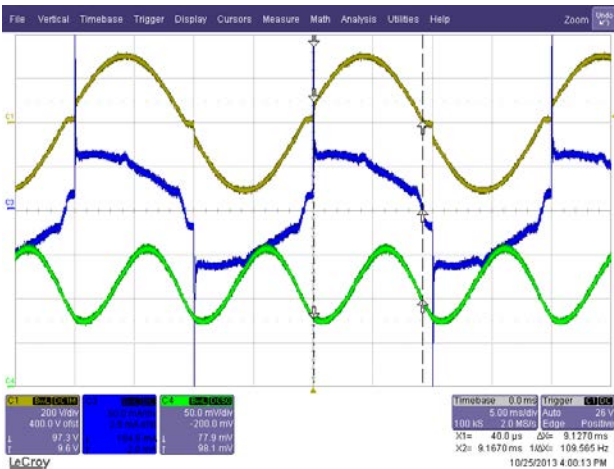
**Figure 187** – Full Conduction from Distorted AC Line 230 V / 50 Hz.  
 Ch1:  $V_{IN}$ ; 200 V / div.  
 Ch3:  $I_{IN}$ ; 50 mA / div.  
 Ch4:  $I_{OUT}$ ; 50 mA / div.  
 Time Scale: 5 ms / div.



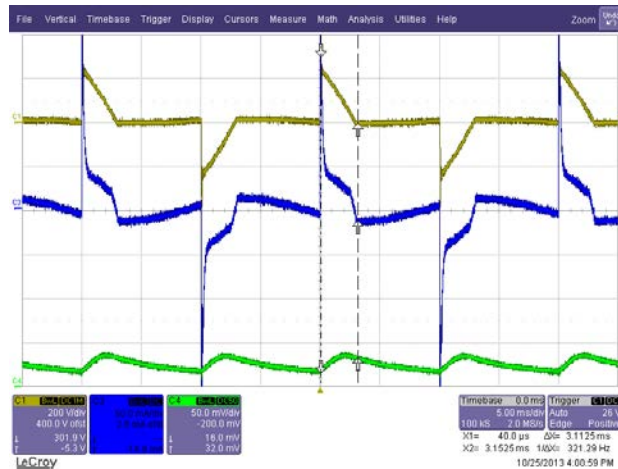
**Figure 188** – Minimum Conduction from Distorted AC Line 230 V / 50 Hz.  
 Ch1:  $V_{IN}$ ; 200 V / div.  
 Ch3:  $I_{IN}$ ; 50 mA / div.  
 Ch4:  $I_{OUT}$ ; 50 mA / div.  
 Time Scale: 5 ms / div.



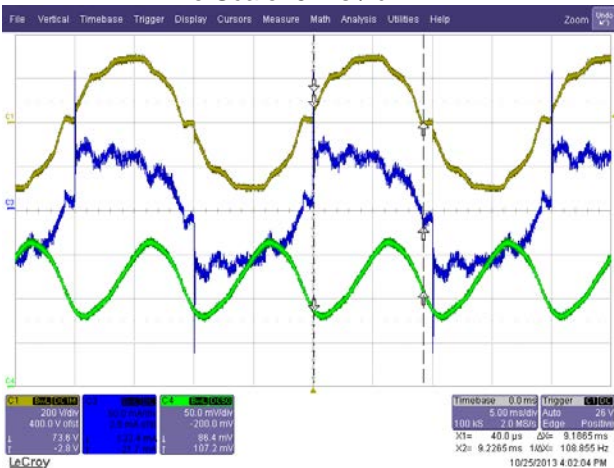
Dimmer: Relco RM34DMA



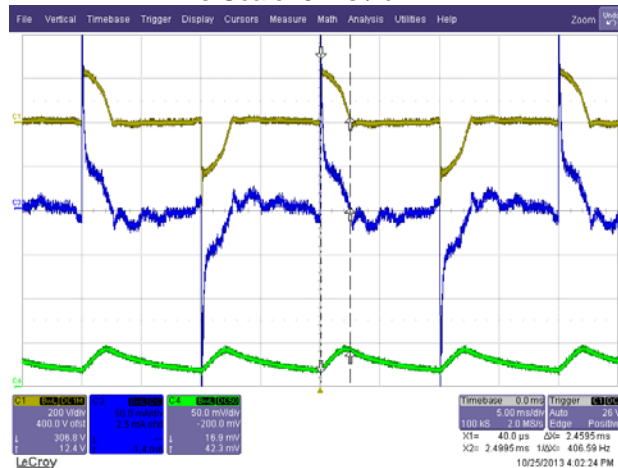
**Figure 189** – Full Conduction from Regulated AC Input 230 V / 50 Hz.  
 Ch1:  $V_{IN}$ ; 200 V / div.  
 Ch3:  $I_{IN}$ ; 50 mA / div.  
 Ch4:  $I_{OUT}$ ; 50 mA / div.  
 Time Scale: 5 ms / div.



**Figure 190** – Minimum Conduction from Regulated AC Input 230 V / 50 Hz.  
 Ch1:  $V_{IN}$ ; 200 V / div.  
 Ch3:  $I_{IN}$ ; 50 mA / div.  
 Ch4:  $I_{OUT}$ ; 50 mA / div.  
 Time Scale: 5 ms / div.



**Figure 191** – Full Conduction from Distorted AC Line 230 V / 50 Hz.  
 Ch1:  $V_{IN}$ ; 200 V / div.  
 Ch3:  $I_{IN}$ ; 50 mA / div.  
 Ch4:  $I_{OUT}$ ; 50 mA / div.  
 Time Scale: 5 ms / div.

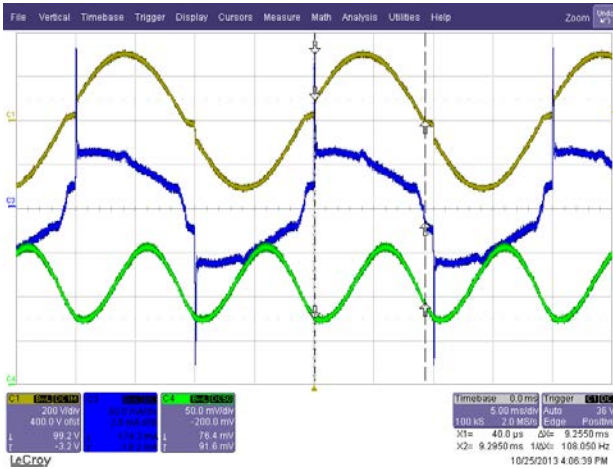


**Figure 192** – Minimum Conduction from Distorted AC Line 230 V / 50 Hz.  
 Ch1:  $V_{IN}$ ; 200 V / div.  
 Ch3:  $I_{IN}$ ; 50 mA / div.  
 Ch4:  $I_{OUT}$ ; 50 mA / div.  
 Time Scale: 5 ms / div.

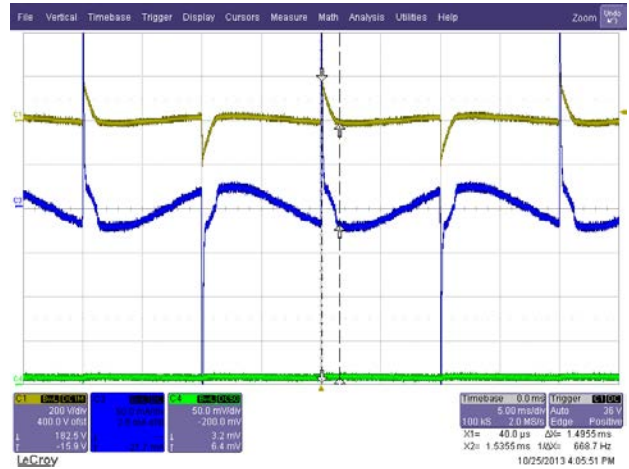




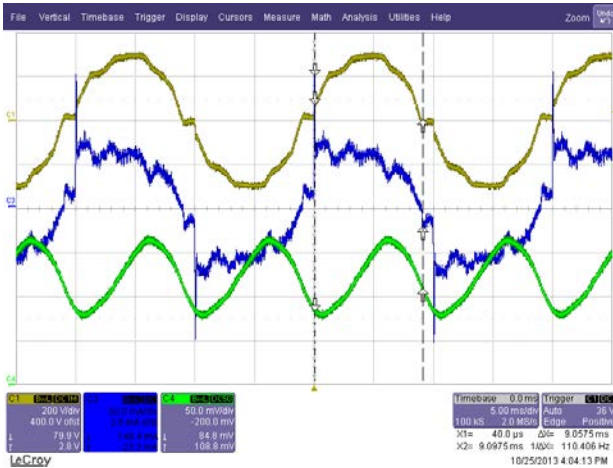
Dimmer: Relco RTS34.43 RLI



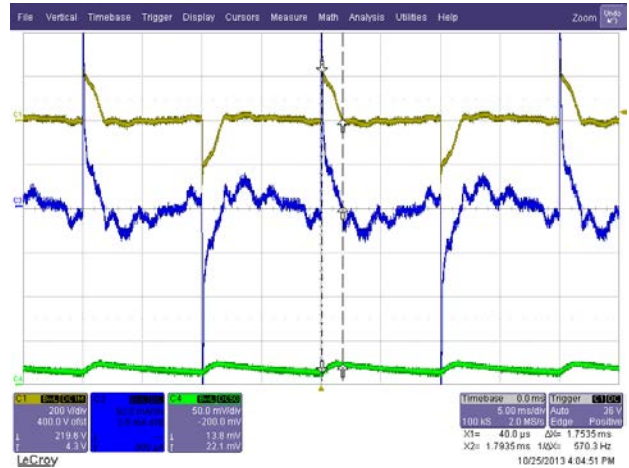
**Figure 193** – Full Conduction from Regulated AC Input 230 V / 50 Hz.  
 Ch1:  $V_{IN}$ ; 200 V / div.  
 Ch3:  $I_{IN}$ ; 50 mA / div.  
 Ch4:  $I_{OUT}$ ; 50 mA / div.  
 Time Scale: 5 ms / div.



**Figure 194** – Minimum Conduction from Regulated AC Input 230 V / 50 Hz.  
 Ch1:  $V_{IN}$ ; 200 V / div.  
 Ch3:  $I_{IN}$ ; 50 mA / div.  
 Ch4:  $I_{OUT}$ ; 50 mA / div.  
 Time Scale: 5 ms / div.



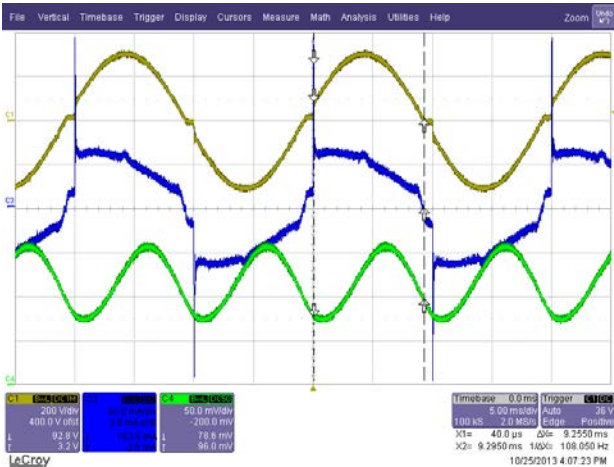
**Figure 195** – Full Conduction from Distorted AC Line 230 V / 50 Hz.  
 Ch1:  $V_{IN}$ ; 200 V / div.  
 Ch3:  $I_{IN}$ ; 50 mA / div.  
 Ch4:  $I_{OUT}$ ; 50 mA / div.  
 Time Scale: 5 ms / div.



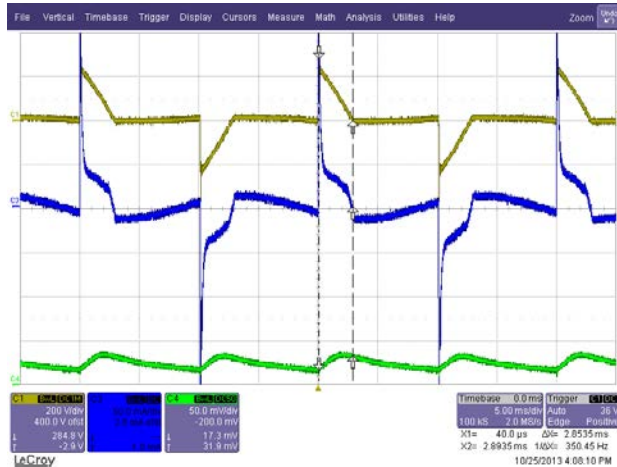
**Figure 196** – Minimum Conduction from Distorted AC Line 230 V / 50 Hz.  
 Ch1:  $V_{IN}$ ; 200 V / div.  
 Ch3:  $I_{IN}$ ; 50 mA / div.  
 Ch4:  $I_{OUT}$ ; 50 mA / div.  
 Time Scale: 5 ms / div.



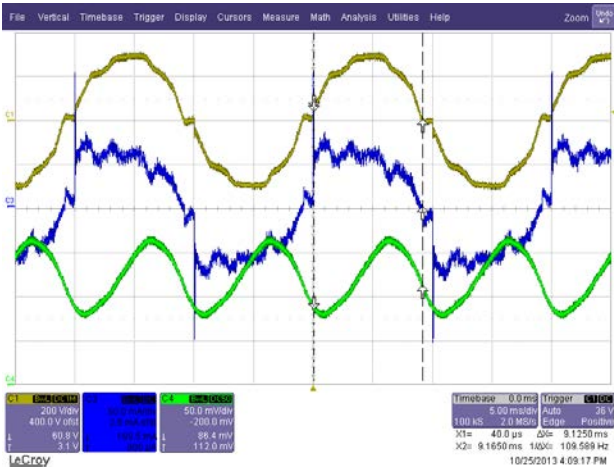
Dimmer: Relco RT34DSL



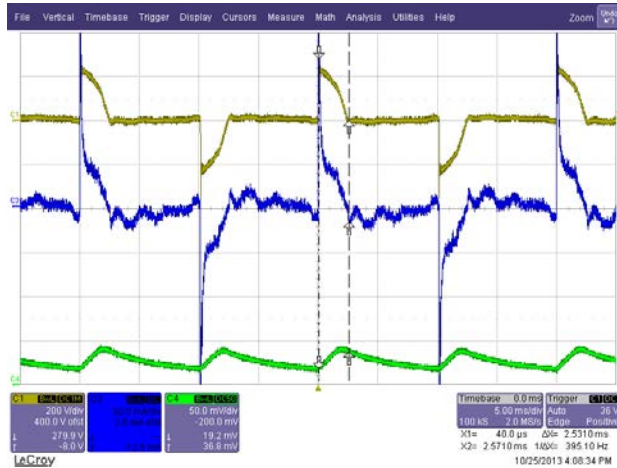
**Figure 197** – Full Conduction from Regulated AC Input 230 V / 50 Hz.  
 Ch1:  $V_{IN}$ ; 200 V / div.  
 Ch3:  $I_{IN}$ ; 50 mA / div.  
 Ch4:  $I_{OUT}$ ; 50 mA / div.  
 Time Scale: 5 ms / div.



**Figure 198** – Minimum Conduction from Regulated AC Input 230 V / 50 Hz.  
 Ch1:  $V_{IN}$ ; 200 V / div.  
 Ch3:  $I_{IN}$ ; 50 mA / div.  
 Ch4:  $I_{OUT}$ ; 50 mA / div.  
 Time Scale: 5 ms / div.

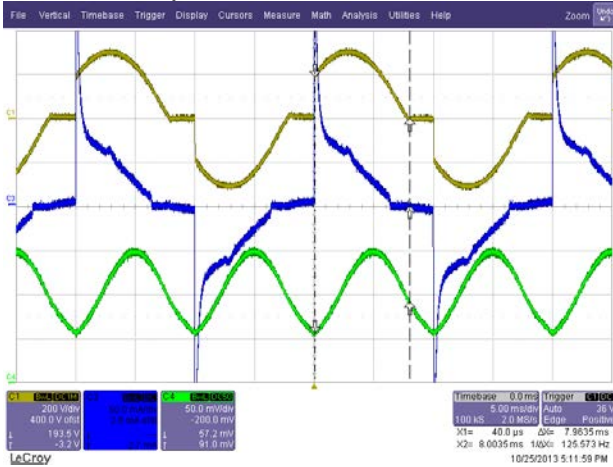


**Figure 199** – Full Conduction from Distorted AC Line 230 V / 50 Hz.  
 Ch1:  $V_{IN}$ ; 200 V / div.  
 Ch3:  $I_{IN}$ ; 50 mA / div.  
 Ch4:  $I_{OUT}$ ; 50 mA / div.  
 Time Scale: 5 ms / div.

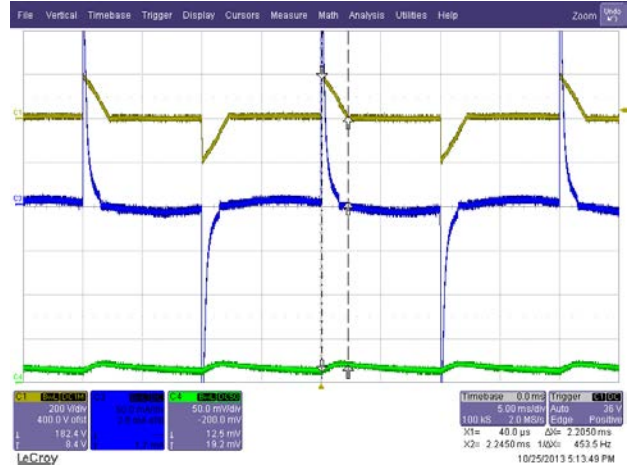


**Figure 200** – Minimum Conduction from Distorted AC Line 230 V / 50 Hz.  
 Ch1:  $V_{IN}$ ; 200 V / div.  
 Ch3:  $I_{IN}$ ; 50 mA / div.  
 Ch4:  $I_{OUT}$ ; 50 mA / div.  
 Time Scale: 5 ms / div.

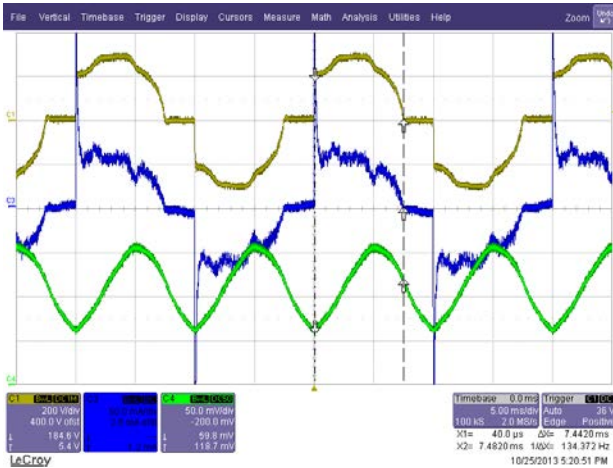
Dimmer: Clipsal 32E450LM



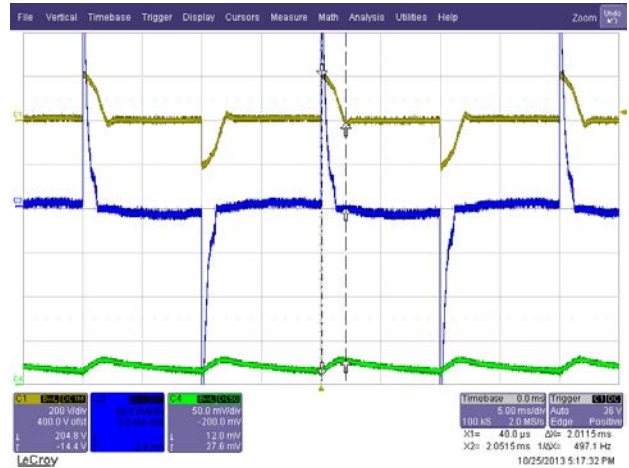
**Figure 201** – Full Conduction from Regulated AC Input 230 V / 50 Hz.  
 Ch1:  $V_{IN}$ ; 200 V / div.  
 Ch3:  $I_{IN}$ ; 50 mA / div.  
 Ch4:  $I_{OUT}$ ; 50 mA / div.  
 Time Scale: 5 ms / div.



**Figure 202** – Minimum Conduction from Regulated AC Input 230 V / 50 Hz.  
 Ch1:  $V_{IN}$ ; 200 V / div.  
 Ch3:  $I_{IN}$ ; 50 mA / div.  
 Ch4:  $I_{OUT}$ ; 50 mA / div.  
 Time Scale: 5 ms / div.



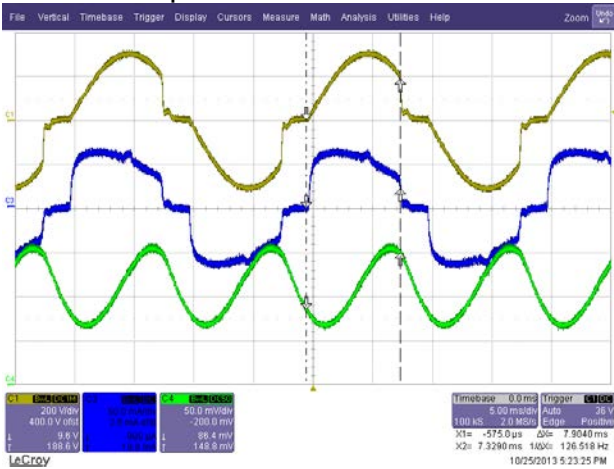
**Figure 203** – Full Conduction from Distorted AC Line 230 V / 50 Hz.  
 Ch1:  $V_{IN}$ ; 200 V / div.  
 Ch3:  $I_{IN}$ ; 50 mA / div.  
 Ch4:  $I_{OUT}$ ; 50 mA / div.  
 Time Scale: 5 ms / div.



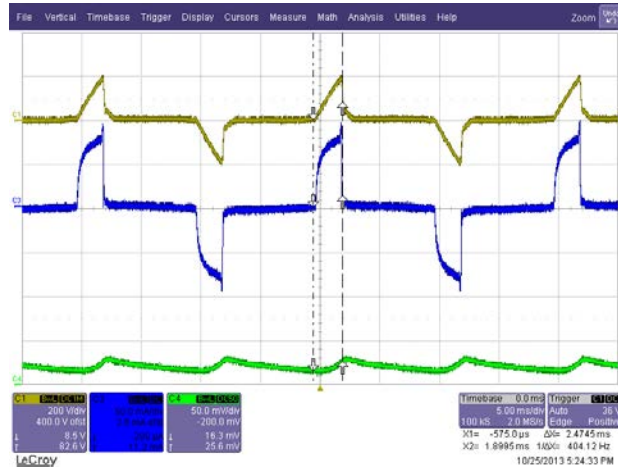
**Figure 204** – Minimum Conduction from Distorted AC Line 230 V / 50 Hz.  
 Ch1:  $V_{IN}$ ; 200 V / div.  
 Ch3:  $I_{IN}$ ; 50 mA / div.  
 Ch4:  $I_{OUT}$ ; 50 mA / div.  
 Time Scale: 5 ms / div.



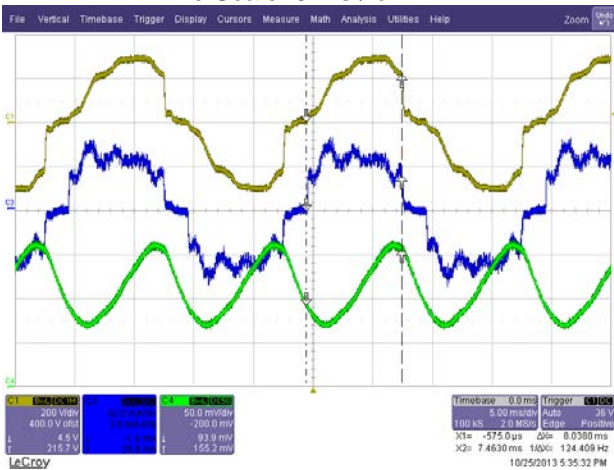
Dimmer: Clipsal 32E450TM



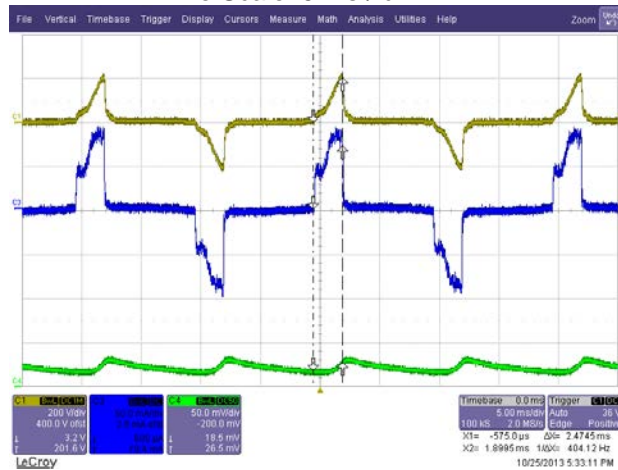
**Figure 205** – Full Conduction from Regulated AC Input 230 V / 50 Hz.  
 Ch1:  $V_{IN}$ ; 200 V / div.  
 Ch3:  $I_{IN}$ ; 50 mA / div.  
 Ch4:  $I_{OUT}$ ; 50 mA / div.  
 Time Scale: 5 ms / div.



**Figure 206** – Minimum Conduction from Regulated AC Input 230 V / 50 Hz.  
 Ch1:  $V_{IN}$ ; 200 V / div.  
 Ch3:  $I_{IN}$ ; 50 mA / div.  
 Ch4:  $I_{OUT}$ ; 50 mA / div.  
 Time Scale: 5 ms / div.



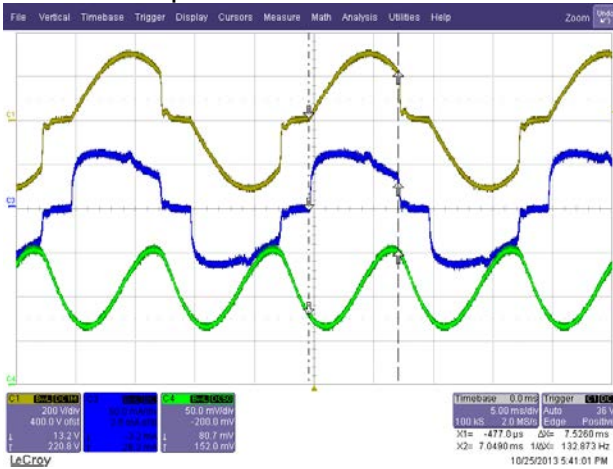
**Figure 207** – Full Conduction from Distorted AC Line 230 V / 50 Hz.  
 Ch1:  $V_{IN}$ ; 200 V / div.  
 Ch3:  $I_{IN}$ ; 50 mA / div.  
 Ch4:  $I_{OUT}$ ; 50 mA / div.  
 Time Scale: 5 ms / div.



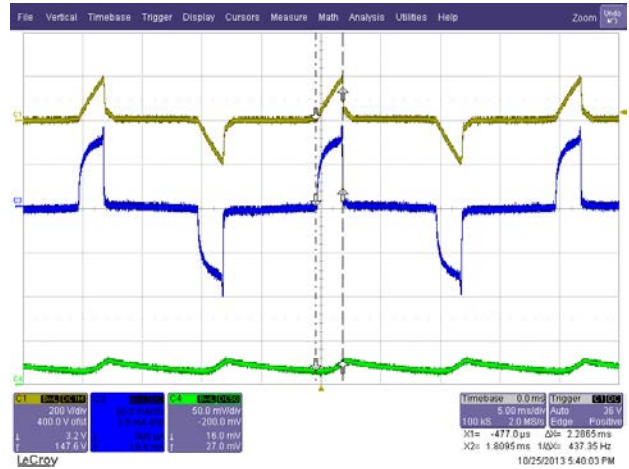
**Figure 208** – Minimum Conduction from Distorted AC Line 230 V / 50 Hz.  
 Ch1:  $V_{IN}$ ; 200 V / div.  
 Ch3:  $I_{IN}$ ; 50 mA / div.  
 Ch4:  $I_{OUT}$ ; 50 mA / div.  
 Time Scale: 5 ms / div.



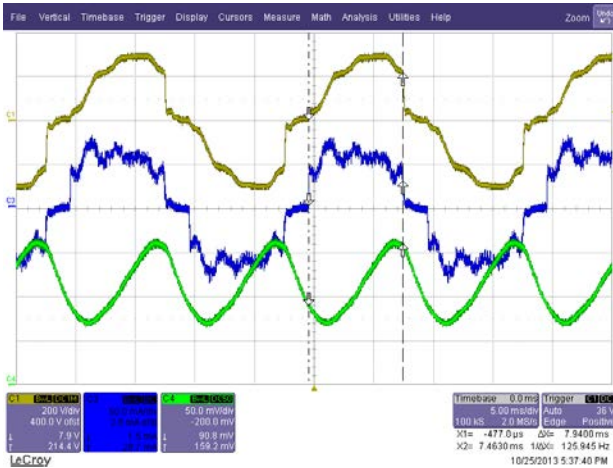
Dimmer: Clipsal 32E2CFLDM



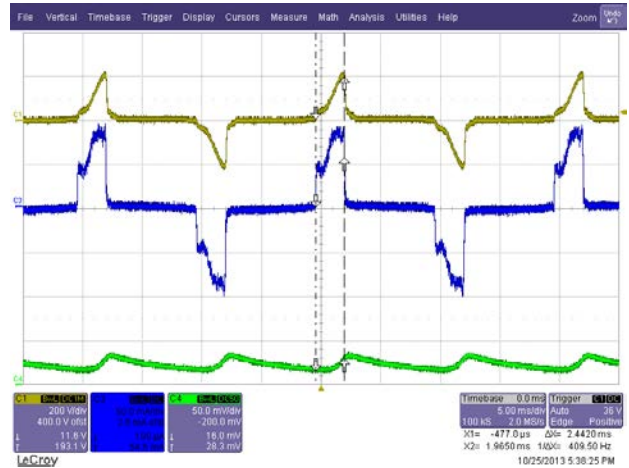
**Figure 209** – Full Conduction from Regulated AC Input 230 V / 50 Hz.  
 Ch1:  $V_{IN}$ ; 200 V / div.  
 Ch3:  $I_{IN}$ ; 50 mA / div.  
 Ch4:  $I_{OUT}$ ; 50 mA / div.  
 Time Scale: 5 ms / div.



**Figure 210** – Minimum Conduction from Regulated AC Input 230 V / 50 Hz.  
 Ch1:  $V_{IN}$ ; 200 V / div.  
 Ch3:  $I_{IN}$ ; 50 mA / div.  
 Ch4:  $I_{OUT}$ ; 50 mA / div.  
 Time Scale: 5 ms / div.



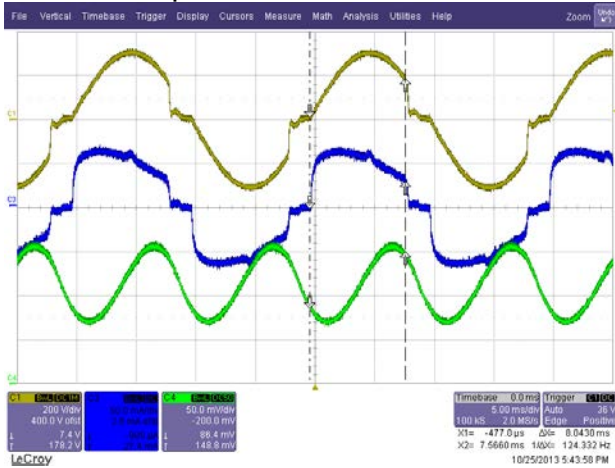
**Figure 211** – Full Conduction from Distorted AC Line 230 V / 50 Hz.  
 Ch1:  $V_{IN}$ ; 200 V / div.  
 Ch3:  $I_{IN}$ ; 50 mA / div.  
 Ch4:  $I_{OUT}$ ; 50 mA / div.  
 Time Scale: 5 ms / div.



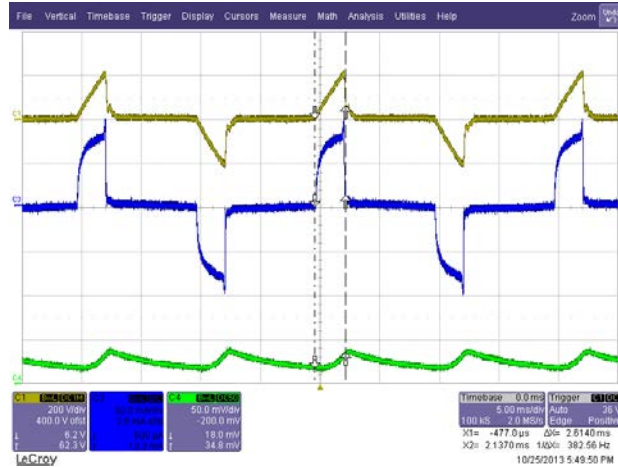
**Figure 212** – Minimum Conduction from Distorted AC Line 230 V / 50 Hz.  
 Ch1:  $V_{IN}$ ; 200 V / div.  
 Ch3:  $I_{IN}$ ; 50 mA / div.  
 Ch4:  $I_{OUT}$ ; 50 mA / div.  
 Time Scale: 5 ms / div.



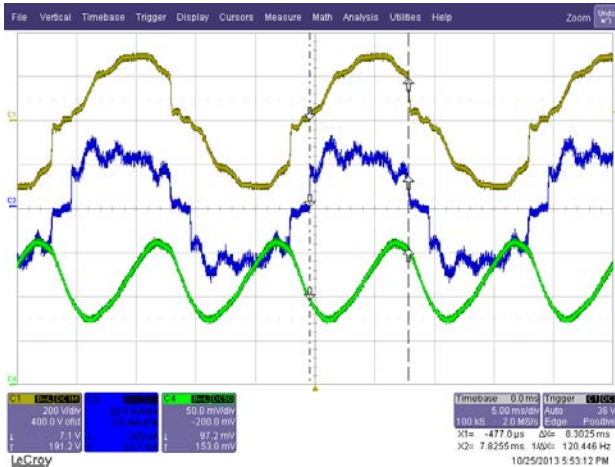
Dimmer: Clipsal 32E450UDM



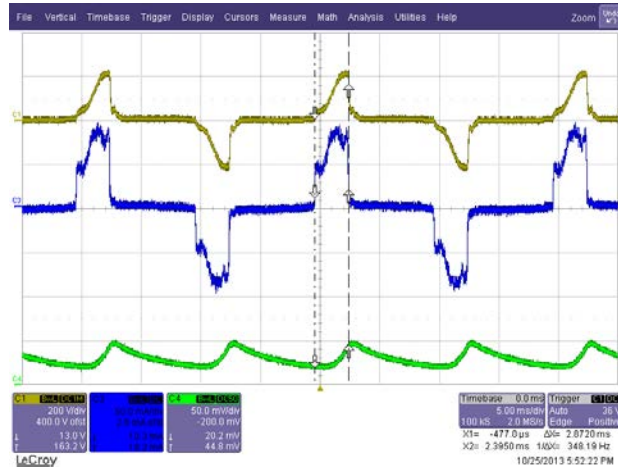
**Figure 213** – Full Conduction from Regulated AC Input 230 V / 50 Hz.  
 Ch1:  $V_{IN}$ ; 200 V / div.  
 Ch3:  $I_{IN}$ ; 50 mA / div.  
 Ch4:  $I_{OUT}$ ; 50 mA / div.  
 Time Scale: 5 ms / div.



**Figure 214** – Minimum Conduction from Regulated AC Input 230 V / 50 Hz.  
 Ch1:  $V_{IN}$ ; 200 V / div.  
 Ch3:  $I_{IN}$ ; 50 mA / div.  
 Ch4:  $I_{OUT}$ ; 50 mA / div.  
 Time Scale: 5 ms / div.



**Figure 215** – Full Conduction from Distorted AC Line 230 V / 50 Hz.  
 Ch1:  $V_{IN}$ ; 200 V / div.  
 Ch3:  $I_{IN}$ ; 50 mA / div.  
 Ch4:  $I_{OUT}$ ; 50 mA / div.  
 Time Scale: 5 ms / div.



**Figure 216** – Minimum Conduction from Distorted AC Line 230 V / 50 Hz.  
 Ch1:  $V_{IN}$ ; 200 V / div.  
 Ch3:  $I_{IN}$ ; 50 mA / div.  
 Ch4:  $I_{OUT}$ ; 50 mA / div.  
 Time Scale: 5 ms / div.





## 14 Line Surge

Differential input Line 1.2/50  $\mu$ s surge testing was completed on a single test unit to IEC61000-4-5. Input voltage was set at 230 VAC / 60 Hz. Output was loaded at full load and operation was verified following each surge event.

Surge Level (V)	Input Voltage (VAC)	Injection Location	Injection Phase (°)	Test Result (Pass/Fail)
+500	230	L to N	90	Pass
-500	230	L to N	90	Pass
+500	230	L to N	270	Pass
-500	230	L to N	270	Pass
+500	230	L to N	0	Pass
-500	230	L to N	0	Pass

Unit passed under all test conditions.

Differential ring input Line surge testing was completed on a single test unit to IEC61000-4-5. Input voltage was set at 230 VAC / 60 Hz. Output was loaded at full load and operation was verified following each surge event.

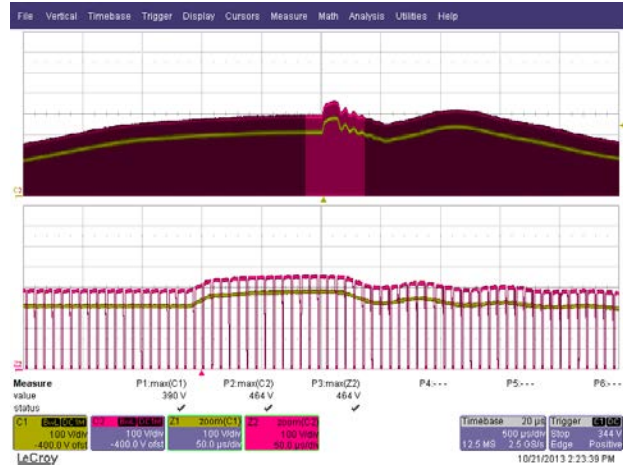
Surge Level (V)	Input Voltage (VAC)	Injection Location	Injection Phase (°)	Test Result (Pass/Fail)
+2500	230	L to N	90	Pass
-2500	230	L to N	90	Pass
+2500	230	L to N	270	Pass
-2500	230	L to N	270	Pass
+2500	230	L to N	0	Pass
-2500	230	L to N	0	Pass

Unit passed under all test conditions.

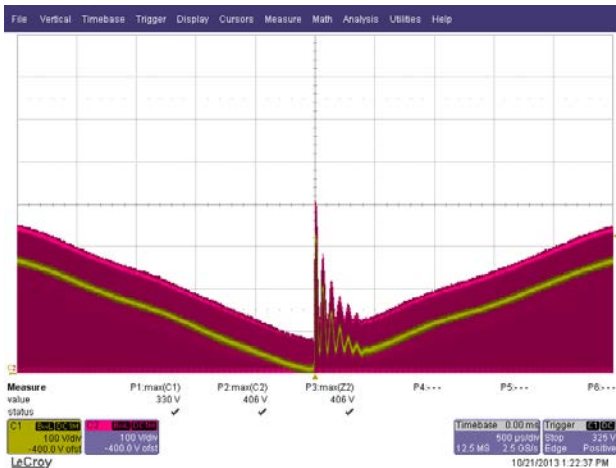




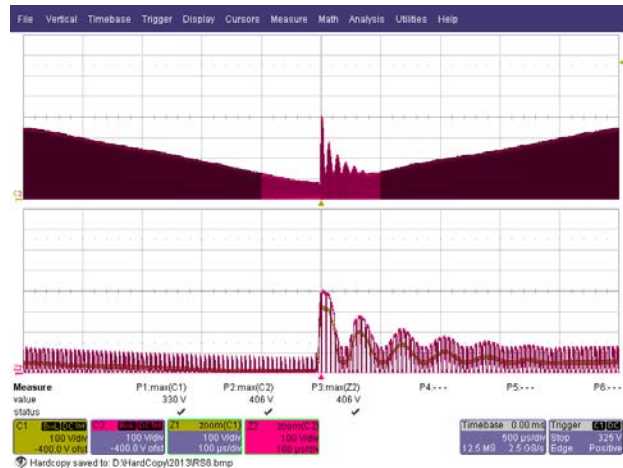
**Figure 217** – Differential Line Surge at 500 V / 90°. Peak Drain Voltage Recorded is 464 V.  
 Ch1:  $V_{BULK}$ ; 100 V / div.  
 F1:  $V_{DRAIN}$ ; 200 V / div.  
 Time Scale: 500  $\mu$ s / div.



**Figure 218** – Differential Line Surge at 500 V / 90°. Peak Drain Voltage Recorded is 464 V.  
 Ch1:  $V_{BULK}$ ; 100 V / div.  
 F1:  $V_{DRAIN}$ ; 200 V / div.  
 Time Scale: 500  $\mu$ s / div.  
 Zoom time Scale: 50  $\mu$ s / div.

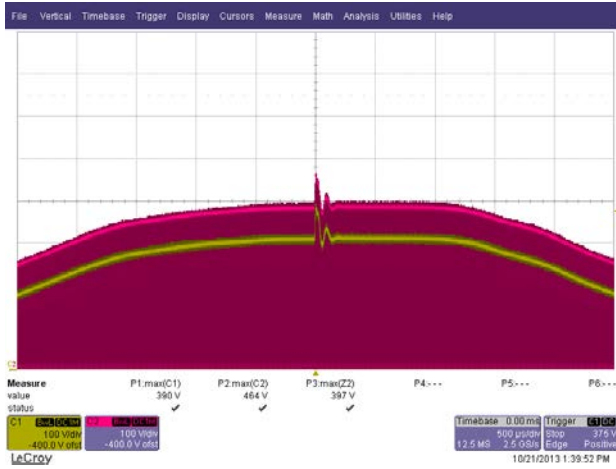


**Figure 219** – Differential Ring Surge at 2500 V / 0°. Peak Drain Voltage Recorded is 406 V.  
 Ch1:  $V_{BULK}$ ; 100 V / div.  
 F1:  $V_{DRAIN}$ ; 100 V / div.  
 Time Scale: 500  $\mu$ s / div.

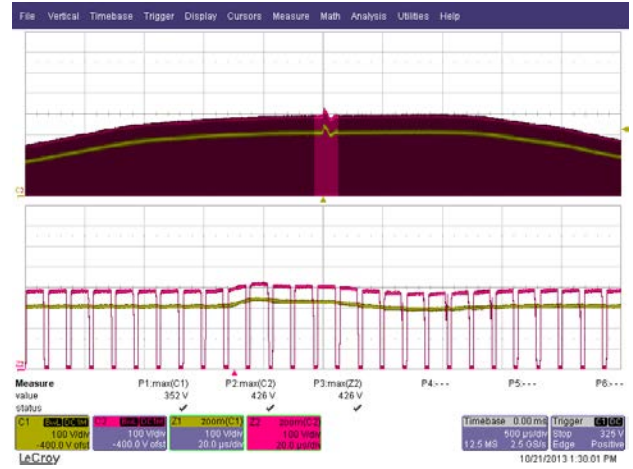


**Figure 220** – Differential Ring Surge at 2500 V / 0°. Peak Drain Voltage Recorded is 406 V.  
 Ch1:  $V_{BULK}$ ; 100 V / div.  
 F1:  $V_{DRAIN}$ ; 100 V / div.  
 Time Scale: 500  $\mu$ s / div.  
 Zoom time Scale: 100  $\mu$ s / div.





**Figure 221** – Differential Ring Surge at 2500 V / 90°. Peak Drain Voltage Recorded is 464 V.  
 Ch1:  $V_{BULK}$ ; 100 V / div.  
 F1:  $V_{DRAIN}$ ; 100 V / div.  
 Time Scale: 500  $\mu$ s / div.



**Figure 222** – Differential Ring Surge at 2500 V / 90°. Peak Drain Voltage Recorded is 426 V.  
 Ch1:  $V_{BULK}$ ; 100 V / div.  
 F1:  $V_{DRAIN}$ ; 100 V / div.  
 Time Scale: 500  $\mu$ s / div.  
 Zoom time Scale: 20  $\mu$ s / div.



## 15 Conducted EMI



**Figure 223** – The Retrofit Lamp was Verified in a Conical Cone as per EN55015.





Power Integrations  
16.Oct 13 21:53

REW 9 kHz  
MT 500 ms

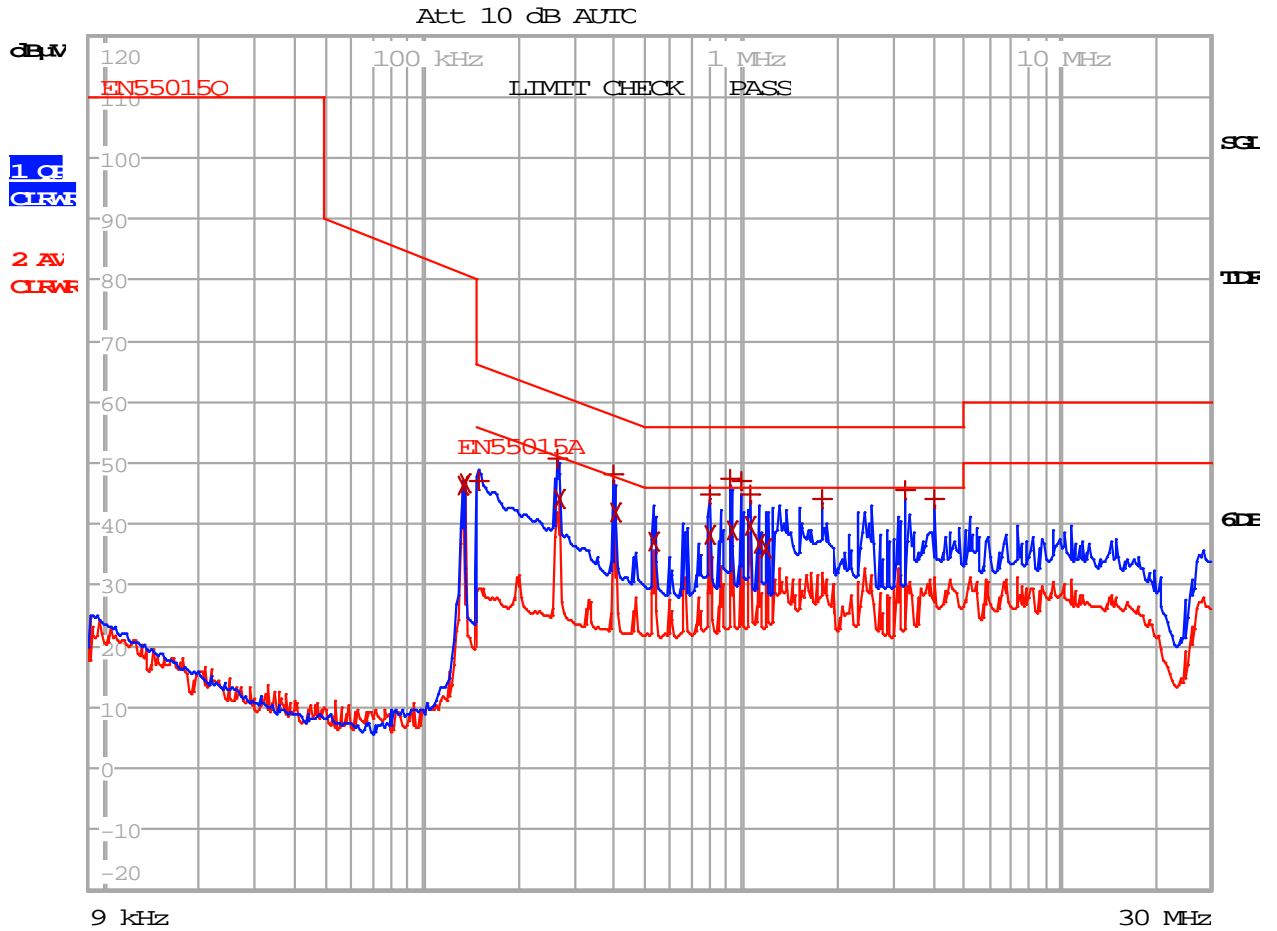


Figure 224 – Conducted EMI, Maximum Steady-State Load, 230 VAC, 60 Hz, and EN55015 B Limits. Enclosed Unit in A19 Bulb Replacement.





EDIT PEAK LIST (Final Measurement Results)					
Trace1:	EN55015Q				
Trace2:	EN55015A				
Trace3:	---				
TRACE	FREQUENCY	LEVEL	dB $\mu$ V		DELTA LIMIT
2 Average	133.454986145 kHz	46.49	L1	gnd	
2 Average	136.137431366 kHz	46.55	L1	gnd	
1 Quasi Peak	151.5 kHz	47.03	L1	gnd	-18.88
1 Quasi Peak	264.49018761 kHz	50.70	N	gnd	-10.58
2 Average	267.135089486 kHz	44.11	N	gnd	-7.09
1 Quasi Peak	397.727746704 kHz	48.11	N	gnd	-9.78
2 Average	401.705024172 kHz	41.76	N	gnd	-6.05
2 Average	530.769219795 kHz	37.13	N	gnd	-8.86
1 Quasi Peak	798.145472681 kHz	44.73	N	gnd	-11.26
2 Average	798.145472681 kHz	38.25	N	gnd	-7.74
1 Quasi Peak	926.622115652 kHz	47.49	N	gnd	-8.50
2 Average	935.888336808 kHz	39.00	N	gnd	-6.99
1 Quasi Peak	993.464328234 kHz	47.04	N	gnd	-8.95
1 Quasi Peak	1.06512822736 MHz	44.92	N	gnd	-11.07
2 Average	1.06512822736 MHz	39.75	N	gnd	-6.24
2 Average	1.13065507631 MHz	36.81	N	gnd	-9.18
2 Average	1.20021314689 MHz	36.19	N	gnd	-9.80
1 Quasi Peak	1.78695382697 MHz	44.28	N	gnd	-11.71
1 Quasi Peak	3.24635311795 MHz	45.49	N	gnd	-10.50
1 Quasi Peak	4.04078721227 MHz	44.26	N	gnd	-11.73

**Table 4** – Conducted EMI, Maximum Steady-State Load, 2390VAC, 60 Hz, and EN55015 B Limits. Enclosed Unit in A19 Bulb Replacement.



**16 Revision History**

<b>Date</b>	<b>Author</b>	<b>Revision</b>	<b>Description &amp; changes</b>	<b>Reviewed</b>
05-Dec-13	JDC	1.0	Initial Release	Apps & Mktg



---

**For the latest updates, visit our website: [www.powerint.com](http://www.powerint.com)**

Power Integrations reserves the right to make changes to its products at any time to improve reliability or manufacturability. Power Integrations does not assume any liability arising from the use of any device or circuit described herein. POWER INTEGRATIONS MAKES NO WARRANTY HEREIN AND SPECIFICALLY DISCLAIMS ALL WARRANTIES INCLUDING, WITHOUT LIMITATION, THE IMPLIED WARRANTIES OF MERCHANTABILITY, FITNESS FOR A PARTICULAR PURPOSE, AND NON-INFRINGEMENT OF THIRD PARTY RIGHTS.

**PATENT INFORMATION**

The products and applications illustrated herein (including transformer construction and circuits' external to the products) may be covered by one or more U.S. and foreign patents, or potentially by pending U.S. and foreign patent applications assigned to Power Integrations. A complete list of Power Integrations' patents may be found at [www.powerint.com](http://www.powerint.com). Power Integrations grants its customers a license under certain patent rights as set forth at <http://www.powerint.com/ip.htm>.

The PI Logo, TOPSwitch, TinySwitch, LinkSwitch, LYTSwitch, DPA-Switch, PeakSwitch, CAPZero, SENZero, LinkZero, HiperPFS, HiperTFS, HiperLCS, Qspeed, EcoSmart, Clampless, E-Shield, Filterfuse, StackFET, PI Expert and PI FACTS are trademarks of Power Integrations, Inc. Other trademarks are property of their respective companies. ©Copyright 2013 Power Integrations, Inc.

---

**Power Integrations Worldwide Sales Support Locations****WORLD HEADQUARTERS**

5245 Hellyer Avenue  
San Jose, CA 95138, USA.  
Main: +1-408-414-9200  
Customer Service:  
Phone: +1-408-414-9665  
Fax: +1-408-414-9765  
*e-mail: [usasales@powerint.com](mailto:usasales@powerint.com)*

**GERMANY**

Lindwurmstrasse 114  
80337, Munich  
Germany  
Phone: +49-895-527-39110  
Fax: +49-895-527-39200  
*e-mail: [eurosales@powerint.com](mailto:eurosales@powerint.com)*

**JAPAN**

Kosei Dai-3 Building  
2-12-11, Shin-Yokohama,  
Kohoku-ku, Yokohama-shi,  
Kanagawa 222-0033  
Japan  
Phone: +81-45-471-1021  
Fax: +81-45-471-3717  
*e-mail: [japansales@powerint.com](mailto:japansales@powerint.com)*

**TAIWAN**

5F, No. 318, Nei Hu Rd.,  
Sec. 1  
Nei Hu District  
Taipei 11493, Taiwan R.O.C.  
Phone: +886-2-2659-4570  
Fax: +886-2-2659-4550  
*e-mail: [taiwansales@powerint.com](mailto:taiwansales@powerint.com)*

**CHINA (SHANGHAI)**

Rm 2410, Charity Plaza, No. 88,  
North Caoxi Road,  
Shanghai, PRC 200030  
Phone: +86-21-6354-6323  
Fax: +86-21-6354-6325  
*e-mail: [chinasales@powerint.com](mailto:chinasales@powerint.com)*

**INDIA**

#1, 14<sup>th</sup> Main Road  
Vasanthanagar  
Bangalore-560052  
India  
Phone: +91-80-4113-8020  
Fax: +91-80-4113-8023  
*e-mail: [indiasales@powerint.com](mailto:indiasales@powerint.com)*

**KOREA**

RM 602, 6FL  
Korea City Air Terminal B/D,  
159-6  
Samsung-Dong, Kangnam-Gu,  
Seoul, 135-728 Korea  
Phone: +82-2-2016-6610  
Fax: +82-2-2016-6630  
*e-mail: [koreasales@powerint.com](mailto:koreasales@powerint.com)*

**EUROPE HQ**

1st Floor, St. James's House  
East Street, Farnham  
Surrey GU9 7TJ  
United Kingdom  
Phone: +44 (0) 1252-730-141  
Fax: +44 (0) 1252-727-689  
*e-mail: [eurosales@powerint.com](mailto:eurosales@powerint.com)*

**CHINA (SHENZHEN)**

3rd Floor, Block A,  
Zhongtuo International Business  
Center, No. 1061, Xiang Mei Rd,  
FuTian District, ShenZhen,  
China, 518040  
Phone: +86-755-8379-3243  
Fax: +86-755-8379-5828  
*e-mail: [chinasales@powerint.com](mailto:chinasales@powerint.com)*

**ITALY**

Via Milanese 20, 3<sup>rd</sup> Fl.  
20099 Sesto San Giovanni  
(MI) Italy  
Phone: +39-024-550-8701  
Fax: +39-028-928-6009  
*e-mail: [eurosales@powerint.com](mailto:eurosales@powerint.com)*

**SINGAPORE**

51 Newton Road,  
#19-01/05 Goldhill Plaza  
Singapore, 308900  
Phone: +65-6358-2160  
Fax: +65-6358-2015  
*e-mail: [singaporesales@powerint.com](mailto:singaporesales@powerint.com)*

**APPLICATIONS HOTLINE**

World Wide +1-408-414-9660

**APPLICATIONS FAX**

World Wide +1-408-414-9760

