

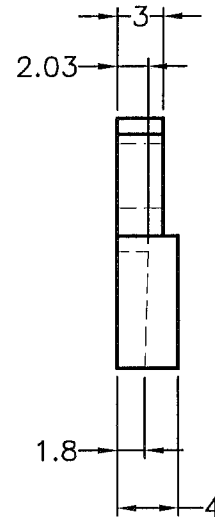

成型尺寸	公差
L≤10	±0.2
10<L≤30	±0.3
30<L≤50	±0.5
50<L≤100	±0.7
100<L≤250	±1.2
ABOVE 250	±1.5

REVISIONS			
REV	DESCRIPTION	DATE	BY

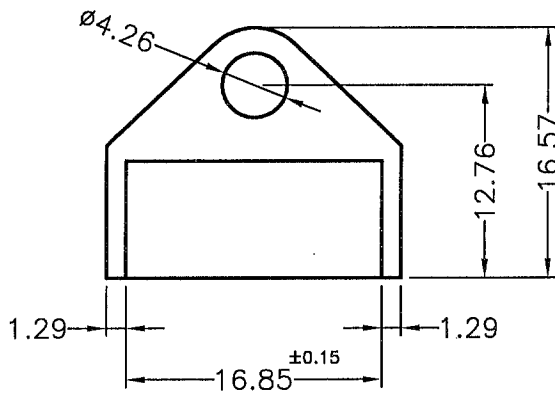
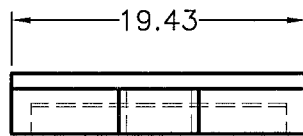
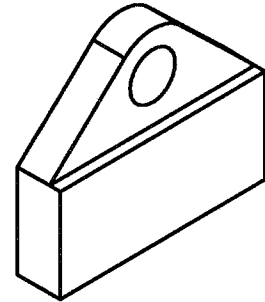
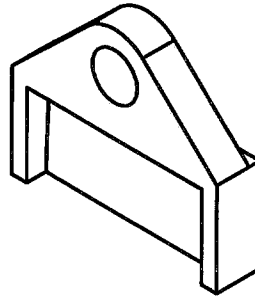
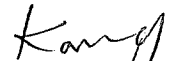

 康揚企業股份有限公司 KANG YANG HARDWARE ENTERPRISE CO., LTD. 康揚塑膠(東莞)有限公司 KANG YANG PLASTIC(DONG GUAN) CO., LTD. ISO 9001 ISO 14001 QG 080000 康哲電腦配件(吳江)有限公司 KANG CHE COMPUTER COMPONENTS(WUJIANG) CO., LTD.		TITLE	CLIP	產品規格圖面	
		MATERIAL	PBT UL94V-0+GF	DATE	2012.12.20
PART NUMBER		FINISH		DRAWN	T.C
EM-340V0B		COLOR	BLACK	CHECK	
DRAWING NUMBER		UNLESS OTHERWISE SPECIFIED TOLERANCE	SEE ABOVE	APPROVED	
EM-340	UNIT	mm	REV	A	
SIZE	A4	SCALE	2:1		